

# Diagnosis of Cardiovascular Diseases by Ensemble Optimization Deep Learning Techniques

David Opeoluwa Oyewola, Department of Mathematics and Statistics, Federal University, Kashere, Nigeria

Emmanuel Gbenga Dada, Department of Computer Science, Faculty of Physical Sciences, University of Maiduguri, Nigeria

Sanjay Misra, Department of Applied Data Science, Institute for Energy Technology, Halden, Norway\*

 <https://orcid.org/0000-0002-3556-9331>

## ABSTRACT

Cardiovascular disease (CVD) is a variety of diseases that affect the blood vessels and the heart. The authors propose a set of deep learning inspired by the approach used in CVD support centers for the early diagnosis of CVD using deep learning techniques. Data were collected from patients who received CVD screening. The authors propose a prediction model to diagnose whether people have CVD or not and to provide awareness or diagnosis on that. The performance of each algorithm is compared with that of long-, short-time memory, feedforward, and cascade forward neural networks, and Elman neural networks. The results show that the ensemble deep learning classification and prediction model achieved 98.45% accuracy. Using the proposed early diagnosis model for CVD can help simplify the diagnosis of CVD by medical professionals.

## KEYWORDS

Cardiovascular Disease, Cascade Forward Neural Network, Elman Neural Network, LSTM

## 1. INTRODUCTION

One of the noticeable infections that affect numerous people during mature age is cardiovascular disease (CVD), and in most cases, it eventually leads to deadly difficulties (Thomas et al., 2018). CVD is the disease of the heart or blood vessels. CVD caused 17.6 million deaths in 2016, which increased to 14.5% from 2006 to 2016 (Naghavi et al., 2017). CVD mortality and dismal state are increasing yearly, particularly in developing regions. Research has indicated that roughly 80% of CVD-related deaths occur in middle-class nations. Moreover, these fatalities occur at a young age among people in high-income nations (Gersh et al., 2010). In developing nations, rapid financial change leads to ecological changes and unhealthy ways of life; Furthermore, aging of the population may increase CVD risk factors and increase the occurrence of CVD (Wu et al., 2016). Based on WHO data, 24% of deaths from nontransferable diseases in India are due to heart diseases (Mackay & Mensah, 2004;

DOI: 10.4018/IJHISI.334021

\*Corresponding Author

This article published as an Open Access article distributed under the terms of the Creative Commons Attribution License (<http://creativecommons.org/licenses/by/4.0/>) which permits unrestricted use, distribution, and production in any medium, provided the author of the original work and original publication source are properly credited.

Vanisree, 2011). A fraction of deaths in the United States and other industrialized nations are due to heart diseases (Patil & Kumaraswamy, 2009). Around 17 million people die from CVD every year around the world, and the diseases are extremely widespread in Asia (Patil & Kumaraswamy, 2009; Vasighi et al., 2013). The specific reason for CVD is unclear, but there are threat factors that are hypertension, high cholesterol levels, diabetes, obesity, age, gender, smoking, and alcohol abuse, and others (Sudhakar, 2014). There are four types of CVD, that is, coronary heart disease, strokes and transient ischemic attack, peripheral arterial ailment, and aortic ailment, but it is difficult to predict CVD chances based on risk factors (Ali, 2013).

Artificial intelligence (AI) strategies can be utilized for the prediction of heart-related problems such as Support Vector Machines (SVM), Naïve Bayes (NB), Neural Networks (NN), Regression (Lauraitis et al., 2019; Naz et al., 2021; Šalkevičius et al., 2019; Wu et al., 2019; Xing et al., 2007). Associative classifiers achieve high precision and robustness compared to conventional classifiers, even in the handling of unstructured data (Miao & Miao, 2018). An improved deep neural network (DNN) was created by (Li et al., 2019) to help people and healthcare professionals and to increase the accuracy and unwavering quality of the medical diagnosis of heart disease. DNN techniques depend on multilayer perceptron (MLP) design with regularization and dropout utilizing deep learning. The evolved DNN techniques consist of a classification model based on training data and a forecast model for identifying new patient cases utilizing information collected from the Cleveland Clinic Foundation which consists of 303 clinical occurrences from patients with coronary heart problems. To analyze the extent of CVD ailment in patients using information from 423,604 people without CVD at baseline, UK Biobank developed the AI technique to predict CVD risk based on 473 accessible factors (Alaa et al., 2019). Machine learning techniques were derived utilizing AutoPrognosis, a tool that chooses and tunes ensembles of the learning model. They contrasted their techniques with a reputable risk forecast technique based on routine CVD threat factors (Framingham score), Cox proportional hazards (PH) techniques based on recognizable threat factors (such as age, smoking, history of diabetes, systolic blood pressure and body mass index), and Cox PH techniques based on all the 473 accessible factors. The enhanced risk prediction techniques of AutoPrognosis have a low performance in terms of the area under the receiver operating characteristic curve (AUC ROC) and the CI compared to the Framingham score. The Cox PH model with traditional risk factors for AUC-ROC of 0.734 and the Cox PH model with all UK Biobank factors have a low AUC-ROC performance of 0.758. Moreover, their techniques proved risk prediction in high-risk population groups, such as people with a history of diabetes mellitus.

Their findings showed that their proposed technique has low performance in terms of sensitivity, precision, diagnostic accuracy, and diagnostic odds ratio. Therefore, there is a need to develop a high-performance, robust, and efficient method of diagnosis. In this paper, we propose an ensemble deep learning technique to predict CVD based on risk factors.

## 2. RELATED WORKS

Several studies have been done in the area of machine learning for cardiovascular disease diagnosis. Uddin and Halder (Uddin & Halder, 2021) proposed a multilayer dynamic system (MLDS) based on the ensemble approach, which may improve understanding in each layer. For feature extraction, the proposed model uses the Correlation Attribute Evaluator (CAE), the Gain Ratio Attribute Evaluator (GRAE), the Information Gain Attribute Evaluator (IGAE), Lasso, and the Extra Trees classifier (ETC). Lastly, the ensemble approach for classification in the model was built using Random Forest (RF), Nave Bayes (NB), and Gradient Boosting (GB) classifiers. While the base classifiers described failed to identify accurately in any layer, the K Nearest Neighbor (KNN) technique finds the test data's neighborhood data points. The study made use of a Kaggle dataset with 70,000 instances. The proposed model achieved a maximum accuracy of 94.16%. Also, it achieved a 0.94 AUC score, indicating that it has a 94 percent chance of accurately identifying positive and negative classes, with an 87.5

to 12.5 dividing ratio. The experiments utilized the Cleveland, Hungarian, and Cleveland-Hungary-Switzerland-Long Beach datasets. The suggested model was compared to five other models and found to be capable of accurately predicting cardiovascular disease. The proposed method's shortcoming is that it does not employ deep learning techniques to scan the data for features that correspond and aggregate them to ensure fast learning without being expressly directed to do so.

Haq et al. (2018) proposed the Random Search Algorithm (RSA) and an optimized model for the Random Forest for enhancing the detection of cardiovascular illness. For the accurate prediction and classification of heart disease, the suggested model used the RSA to choose features and modify the Random Forest classifier. The data was gathered from the machine learning repository at UC Irvine. The collection contains a total of 303 instances. Two hundred and ninety-seven of them contain comprehensive attribute information, while six occurrences have missing information. The research work's limitation is that no intelligent technique was employed to choose the subset of attributes in this study. The RSA method creates locations that are totally unpredictable. Some of the drawbacks of the method are that it is time-wasting, attributable to the ambiguity about which subset of features the model should assign best accuracy.

Javeed et al. (2019) presented a model for categorizing heart disease prediction. The Chi-Squared feature extraction technique was used to pick the features, and then Principle Component Analysis (PCA) was used to find the principal components. For the classification problem, they employed six classifiers. Four types of experiments were conducted. This includes classification of the original data with all the classifiers. Secondly, the Chi-Square feature selection approach is used to obtain useful features and authenticate the features with the classifiers. Thirdly, Chi-Square was used to trim down the dataset before using PCA for classification. Finally, PCA was used on the raw data. The limitation of the work is that it is problematic to ascertain the number of principal components to retain practically since fundamental features of a dataset will become principal components. Therefore, there is a likelihood of losing features while choosing the principal components in contrast to the initial list of features.

G'arate-Escamila et al. (2020) developed a hybrid intelligence system for predicting cardiac disease. The authors employed the K-fold cross-validation technique, three feature selection methods, and seven classifiers. They kept track of the accuracy of multiple classifiers using features produced by various feature selection algorithms. The Cleveland dataset from the UCI machine learning repository, containing 303 instances, was used to conduct the experiment. Only 297 instances have comprehensive attribute information, while six instances have missing details. The limitation of the model is that the training method must be rerun k times from the beginning. Consequently, huge datasets are not suited for this architecture because completing a single computing task takes a substantially longer time.

Mienye et al. (2020) presented a new ensemble learning approach for predicting the risk of heart disease. The model divided the entire dataset into smaller subsets using the mean-based splitting strategy and then classified each partition using the Classification and Regression Tree (CART) algorithm. An accuracy-based weighted aging ensemble (WAE) is used to construct a homogenous ensemble from different CART models. The researchers utilized two heart disease datasets for their study: the Cleveland dataset (303 occurrences) and the Framingham dataset (4238 instances). The lack of an optimization approach to determine appropriate attributes for the model is a shortcoming of this study. Moreover, the system is unable to manage noisy data, which may result in the formation of a chaotic decision tree.

Louridi et al. (2019) proposed a machine learning algorithm to identify cardiovascular illness by employing 303 samples with 13 attributes. For classification, they employed Support Vector Machine (SVM), KNN (K Nearest Neighbor), and Bayes Naif (BN). The SVM-linear kernel achieves a maximum accuracy of 86.8%. The researchers' research has a disadvantage in that they only dealt with missing values in the preprocessing unit, although feature selection is critical for improving accuracy and minimizing processing time. It assists in the selection of useful qualities that have a major impact on the desired outcome.

Gao et al. (2021) applied the ensemble method for heart disease prediction. The proposed model used 1025 cases with 13 independent attributes obtained from Kaggle. The important features are selected using two feature selection algorithms (linear discriminant analysis and principal component analysis). The ensemble approach was created using KNN, SVM, DT, RF, and NB. Heart disease can be classified using both boosting and bagging procedures. Their proposed model achieved the greatest accuracy of 98.6% for the bagging ensemble learning method with a decision tree. The drawbacks of this work include high time complexity at the training stage and the susceptibility of the system to lose certain information when choosing principal components as compared to the initial list of attributes.

Geetha Devi (2021) developed a machine learning-based cardiovascular disease prediction model. The Cleveland heart disease dataset, which has 303 instances from the UCI database, was used for the experiments. Cardiovascular disease was classified using the kNN algorithm. This proposed model has a maximum accuracy of 87%. One of the limitations of their work is that their model has no feature selection algorithm. Moreover, important feature selection was not done automatically but manually by the researchers. The implication of this is that their model will not work well with a dataset that has a huge number of attributes. Also, while a single classifier is utilized to draw conclusions in their model, it is preferable to make decisions based on several classifiers.

Nawaz et al. (2021) presented a gradient descent optimization (GDO) model for intelligently predicting cardiovascular disease. Among the different prediction models studied by the authors, the proposed system yields better results. The accuracy of the GDO-based model was 98.54 percent, the sensitivity was 99.43 percent, and the precision was 97.76 percent. The system's prediction findings indicate that it can be used to diagnose cardiovascular disease. The proposed technology will aid in the investigation of cardiovascular illness. The limitation of the work is that the size of the dataset used for the experiment is relatively small. Therefore, the effectiveness of the method cannot be ascertained.

Jafari et al. (2023) conducted a study that offers an in-depth review of CVD screening studies utilising CMR images and DL approaches. They investigated the many forms of CVDs, detection approaches, and some of the essential kinds of medical imaging. The authors also discuss CVD detection using CMR pictures and the most important DL approaches. They reviewed the difficulties in identifying CVDs using CMRI data. The findings of this evaluation, as well as potential future research in CVD diagnosis using CMR imaging and DL approaches, are discussed. Furthermore, several of the most significant discoveries of this investigation CVDs have a detrimental effect on both the structure and function of the cardiovascular muscle, putting individuals at risk globally. The most serious CVDs are coronary artery disease, cardiac arrhythmia, heart attack, myocarditis, and HCD. CVDs are heart or blood vessel disorders caused by the formation of fatty substances within artery walls and a higher likelihood of clots in the bloodstream. High blood pressure that is not under control can cause artery hardening and thickening, as well as constriction of the vessels that carry blood.

Calisto et al. (2022) developed a technique for screening breast cancer using artificial intelligence in clinician-only and clinician-AI settings. The uniqueness stems from the incorporation of a deep learning algorithm into a real-world clinical procedure for medical imaging diagnostics. The study looked at how physicians adopt and communicate with these technologies, as well as whether instructions and capabilities are needed. How they react to the emergence of AI-assisted technologies by delivering advantages such as medical mistake reduction and the way they are influenced by artificial intelligence (AI) support. The authors undertake a thorough review that includes choosing participants with varying degrees of severity and conducting qualitative and quantitative assessments for each patient picked under the two different conditions. They contrast the test results and notice the advantages of the Clinician-AI situation, as they acquired a 27% reduction in false positives and a 4% reduction in false negatives. They find from a comprehensive research study that the recommended design strategies improve the desired outcomes and perceptual fulfilment of 91% of clinicians while reducing the time to diagnose by 3 minutes for each patient. The technique's shortcoming is that performance is still poor.

Zhang et al. (2023) presented an internet of things physics-guided deep learning network for the operational evaluation of cardiovascular disease. They precisely developed a responsive network to establish useful characteristics while keeping the coronary artery physiology traits and arterial parts in mind. They integrated sensory information about blood circulation into the loss function to achieve an evaluation of function with comprehensibility. It might guarantee that functional evaluation adheres to physical laws. Numerous experiments are carried out on both an artificial and a real-life medical dataset. The findings demonstrate that our method may provide reliable as well as physically accurate evaluations. Furthermore, their strategy encourages greater IoT and deep learning usage in the discipline of smart health.

Calisto et al. (2017) present simple platforms that enable radiologists to undertake an accurate optical examination and efficiently delineate tumours. They investigated the radiologist's openness to the existing interactive interface approach. The benefits of touch include greater time efficiency over conventional approaches. It also provides simpler commands, and, in a quicker manner, the user display provides additional details for each annotation operation. Based on our findings, radiologists continue to be resistant to switching from conventional to touch-based displays in contemporary medical environments.

Tseng et al. (2023) did a study to see if a retinal biomarker based on deep learning could be used to predict cardiovascular disease (Reti-CVD). Based on optimised thresholds from the UK Biobank, the proposed ratings were generated and stratified into three distinct categories of danger. The performance of the model was assessed to measure its capacity to predict CVD occurrences in the entire population. In the borderline risk category and three susceptible subdivisions, C-statistics were utilised to evaluate the predictive utility of the model. Their approach offers the ability to detect those with a ten percent 10-year CVD risk who could profit from initial CVD prevention treatments. The authors thought that the approach could be used as a risk amplifying tool to help increase the accuracy of discrimination in people with a ten-year cardiovascular disease risk score between 7.5 and 10%, especially in older people who may be more likely to get the disease. The study's shortcoming is that only statistically based measures were used to evaluate the system's performance.

Aarthy and Iqbal (2023) classified electrocardiogram (ECG) readings for cardiac conditions using an adapted parametric-based AlexNet framework. The deep learning network was demonstrated for identifying ECG signals, and features have been extracted to enhance disease categorization. An aggregate of 5,655 electrocardiogram (ECG) readings were utilised in the study. Every one of the 30-s impulse was first transformed into images in RGB, after which the resulting images were input into AlexNet, which had been trained with significantly adjusted values. Based on the outcomes, the proposed approach not only surpasses contemporary techniques with 98.82% accuracy. It also has superior recall of 98.9% and precision of 97.9% overall. The disadvantage is that the accuracy needs to be improved further.

Yu et al. (2023) used a new technique to detect cardiovascular diseases using Raman images and medical history. First, the approach turns RS data into images of different quality to make things more complicated. Then, a two-branch architecture is used to add insertions that help the multiple-scale feature mining function work better. It then went ahead to improve classification ability by integrating the RS and historical data. The researchers conducted comprehensive testing of the approach and discovered that it performed exceptionally well on their internally generated dataset, with an accuracy of about 93%. The authors opined from their findings that the M3S outperforms current approaches for detecting CVD subgroups.

The motivation for this research is because ensemble learning method is being used to enhance robustness, accuracy, greater generalization, and lower error rate, according to the literature reviewed. The ensemble approach is constructed in two stages. During the initial stage, all the base learners are trained, and each of these learners is created simultaneously, with each learner's production having an impact on the other learners.

**Table 1. Summary of contributions and research gaps in cardiovascular prediction and diagnosis**

Author and Year	Technique Used	Contribution(s)	Research Gap(s)
Uddin and Halder (2021)	Multilayer Dynamic System (MLDS) Ensemble method for cardiovascular disease prediction.	Accurate of 94.16%. and 0.94 AUC value.	The model cannot scan the data for features that correspond and aggregate them to ensure fast learning without being expressly directed to do so
Haq et al. (2018)	Random Search Algorithm (RSA) and Random Forest for enhancing the detection of cardiovascular disease.	Satisfactory performance.	No intelligent technique was employed to choose the subset of attributes in this study. The RSA method creates locations that are totally unpredictable. The method requires a lot of time to select important attributes.
Javeed et al. (2019)	Feature selection and PCA for heart disease prediction.	Best prediction accuracy of accuracy 98.7% for Cleveland, 99.0% for Hungarian, and 99.4% for Cleveland-Hungarian (CH) datasets using Chi-square and principal component analysis (CHI-PCA) with random forests (RF).	The method is problematic. There is a likelihood of losing features while choosing the principal components in contrast to the initial list of features
G'arate-Escamila et al. (2020)	Hybrid intelligence system for predicting cardiac disease	Logistic regression attained 89% accuracy with 10-fold cross-validation .	Training method must be rerun k times from the beginning. Therefore, large datasets are not suited for the architecture because completing a single computing task takes substantially longer time.
Mienye et al. (2020)	Ensemble learning approach for predicting the risk of heart disease	Accuracy of 93% on Cleveland dataset, and 91% accuracy for Framingham dataset.	The use of no optimization approach to determine important attributes for the model. Also, inability to manage noisy data which may result in the formation of a chaotic decision tree.
Louridi et al. (2019)	Support Vector Machine (SVM), KNN (K Nearest Neighbor), and Bayes Naif (BN), with SVM-linear kernel for detection of cardiovascular illness.	Maximum accuracy of 86.8%.	Low performance. The system only dealt with missing values in the preprocessing unit.
Gao et al. (2021)	Ensemble machine learning for heart disease prediction.	Highest accuracy of 98.6%.	High time complexity at the training stage, and the susceptibility of the system to lose certain information when choosing principal components as compared to the initial list of attributes.
Geetha Devi, (2021)	Machine learning for cardiovascular disease prediction.	Maximum accuracy of 87%.	Absence of feature selection algorithm. Also, important features are selected manually. The model will not work well with a dataset that has huge number of attributes.
Nawaz et al. (2021)	Gradient descent optimization (GDO) for cardiovascular disease prediction.	Maximum accuracy of 98.54%, sensitivity of 99.43%, and precision of 97.76%.	Size of the dataset used for the experiment is relatively small. Therefore, the effectiveness of the method cannot be ascertained.
Jafari et al. (2023)	Review of CVD screening studies utilizing CMR images and DL approaches.	The most dangerous CVDs are coronary artery disease, cardiac arrhythmia, heart attack, myocarditis, and HCD	No experiment was conducted to validate the claims of the authors.

*continued on following page*

Table 1. Continued

Author and Year	Technique Used	Contribution(s)	Research Gap(s)
Calisto et al. (2022)	Artificial Intelligence for breast screening.	Enhanced the anticipated results and perceptual satisfaction of 91% of clinicians while decreasing diagnosis time by 3 minutes for each patient.	Performance still needs to be improved.
Zhang et al. (2023)	Physics-guided deep learning network for the evaluation of cardiovascular disease.	Recommended more IoT and deep learning usage in smart health.	Relatively poor performance.
Calisto et al. (2017)	Touch-based medical image diagnosis annotation.	Simplified commands, to display users' additional details.	Need to further enhance the accuracy of the system.
Tseng et al. (2023)	Retinal biomarker based deep learning for predicting cardiovascular disease.	Cardiovascular risk score between 7.5 and 10%, in older people.	The true performance of the system cannot be ascertained as only statistically based measures were used to evaluate the system.
Aarthy and Iqbal (2023)	Modified parametric-based AlexNet for cardiovascular diseases classification.	It achieved 98.82% accuracy.	The accuracy needs to be improved further.
Yu et al. (2023)	Multi-modality multi-scale cardiovascular disease classification.	Recorded an accuracy of about 93%.	Need to enhance the performance of the system.

With the rising number of deaths due to heart failure, developing a model for clearly and efficiently detecting heart disease has become critical. The provision of dependable facilities at reasonable pricing is a major issue for medical institutions such as healthcare centers, and hospitals. The existing models' major issues are accuracy, utility, and dependability. The goal of the study is to find the most effective deep learning technique for diagnosing cardiac disease with greater precision, accuracy, and sensitivity.

### 3. MATERIALS AND METHODS

We used a Kaggle cardiovascular data set (Kaggle, n.d.). The data set has 12 attributes and 70,000 instances. Patients from both genders were selected in this data set. The height and weight of the patient are inclusive of the attributes. The next attribute *ap hi* is the reading of systolic blood pressure, while *ap lo* is the reading of diastolic blood pressure. Smoking is used to determine whether the patient smokes or not, and *alco* is the alcohol level of the patient, while *active* is used to determine the physical activity of the patient. The attribute has a value of 0 for normal or non-CVD and 1 for patients with CVD.

The data set was partitioned into a training set (60%) and a testing set (40%), and the classifiers are trained using the training data set. The performance of the classifiers is examined in the testing dataset. The Kaggle Cardiovascular Dataset is relevant for training and testing purposes due to its extensive collection of health-related data, specifically focusing on cardiovascular diseases. Cardiovascular diseases are a leading cause of mortality worldwide, and early detection and accurate prediction are crucial for effective medical interventions and public health initiatives. This dataset provides a rich and diverse set of features, including patient demographics, clinical measurements, and lifestyle factors, making it well-suited for training and evaluating machine learning models for predicting cardiovascular risks. The choice of this dataset is motivated by its relevance to research in the field of healthcare and predictive analytics. Cardiovascular diseases are a significant global health concern, and developing accurate prediction models can aid in identifying high-risk individuals for early intervention and personalized treatment plans. Machine learning models trained on this dataset have the potential to assist healthcare professionals in making data-driven decisions, reducing

the burden of cardiovascular diseases, and improving overall patient outcomes. A comprehensive analysis of the dataset reveals several strengths and limitations. The dataset’s strengths include its large size, providing a substantial amount of data for training complex machine learning models. It encompasses a wide range of features, allowing for a comprehensive assessment of cardiovascular risk factors. Moreover, the dataset has been preprocessed and cleaned, reducing the need for extensive data preparation efforts. However, some limitations should be considered when using this dataset. It is essential to verify the quality and accuracy of the data, as errors or missing values can impact model performance.

### 3.1 Long Short-Term Memory (LSTM)

The LSTM cell differentiates itself from the conventional recurrent layer in two viewpoints (Guanghua et al., 2018). To start with, the cell state is divided into two components, long-term state  $ct$  and short term state  $ht$ . Another reason was that the three control gates along the state path: forget gate, input gate, as well as output gate, is included to control the cell states. The forget gate  $ft$  regulates the data eliminated from the past long-term state  $ct - 1$ . The output gate  $ot$  controls the development of the present short-term state  $ht$  utilizing the data from the present long-term state. The LSTM cell is outlined in Figure 1.

We can describe it using the following:

$$f_t = \rho(W_f \cdot [h_{t-1}, x_t] + b_f) \tag{1}$$

$$i_t = \rho(W_i \cdot [h_{t-1}, x_t] + b_i) \tag{2}$$

$$c_t = \tanh(W_c \cdot [h_{t-1}, x_t] + b_c) \tag{3}$$

Figure 1. Schematic diagram of long short term memory

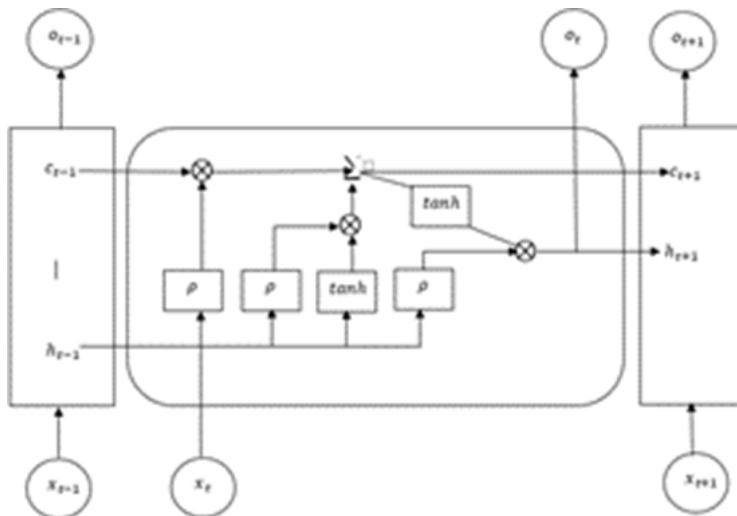



$$o_t = \rho(W_o \cdot [h_{t-1}, x_t] + b_o) \quad (4)$$

$$h_t = o_t \times \tanh(c_t) \quad (5)$$

where  $f_t$  forget gate vector,  $i_t$  input gate vector,  $c_t$  cell state vector,  $o_t$  output gate vector,  $x_t$  is the input vector,  $h_t$  is the output vector,  $\rho$  is the sigmoid function and  $W, b$  is the parameter matrix and vector.

### 3.2 Elman Neural Network (ELMAN)

An Elman network incorporates context nodes. Every context node gets input from a hidden node and transmits its output to a hidden node. Since the context nodes rely upon the activations of the hidden nodes from the past input, the context nodes keep the state data among inputs (Budhani et al., 2014). The Elman network utilized in this paper is illustrated in Figure 2. The mathematical representation of Elman is as follows. The external input vector is given as:

$$x(t) = [x_1(t), x_2(t), \dots, x_n(t)]^T \quad (6)$$

The output vector is:

$$y(t) = [y_1(t), y_2(t), \dots, y_n(t)]^T \quad (7)$$

The output vector of the hidden layer is given as:

$$c(t-1) = [c_1(t-1), c_2(t-1), \dots, c_m(t-1)]^T \quad (8)$$

The output vector connected to the hidden layer is:

$$x^2(t) = [x_1^2(t), x_2^2(t), \dots, x_m^2(t)]^T = c(t-1) \quad (9)$$

The overall input vector is described as:

$$x(t) = [x_1(t), x_2(t), \dots, x_n(t); x_{n+1}^2(t), \dots, x_k^2(t)]^T = [x(t)]^T [x^2(t)]^T = [x_1(t), x_2(t), \dots, x_n(t), c_1^2(t-1), c_m^2(t-1)]^T \quad (10)$$

where  $k = m + n$ .

The output vector can be utilized by the Eqs:

$$y_i(t) = f(a_i^o(t)) = \frac{1}{1 + \exp(-a_i^o(t))}, i = 1, 2, \dots, n \quad (11)$$

$$a_i^o(t) = \sum_{j=1}^m W_{ji}^{o,h}(t) \times h_j(t), i = 1, 2, \dots, n \quad (12)$$

The relations between the input layer weight matrix, the context layer weight matrix, and the hidden layer weight matrix can be expressed as:

$$W^h(t) = [W^{h,i}(t) W^{h,c}(t)] \quad (13)$$

The output of the input vector  $x(t)$  is expressed as:

$$h_j(t) = f(a_j^h(t)) = \frac{1}{1 + \exp(-a_j^h(t))}, j = 1, 2, \dots, m \quad (14)$$

$$a_j^h(t) = \sum_{l=1}^k W_{jl}^h(t) \times x_l(t), j = 1, 2, \dots, m \quad (15)$$

ELMAN training aims to minimize MSE:

$$E(t) = \frac{\|e(t)\|^2}{2} \quad (16)$$

$$e(t) = d(t) - y(t) \quad (17)$$

Here,  $d(t)$  are the desired outputs. The training algorithm decreases  $E(t)$  by estimating the weight:

$$W^{o,h}(t+1) = W^{o,h}(t) - \mu \frac{\partial E(t)}{\partial W^{o,h}(t)} = W^{o,h}(t) - \mu y'(t) e(t) h^T(t) \quad (18)$$

$$W^h(t+1) = W^h(t) - \mu \frac{\partial E(t)}{\partial W^h(t)} = W^h(t) + \mu h'(t) [W^{o,h}(t)]^T y'(t) e(t) x^T(t) \quad (19)$$

where  $\mu$  is the learning rate of ELMAN,  $y'(t)$  and  $h'(t)$  is given below:

$$y'(t) = \text{diag}[f'(a_1^o(t)), f'(a_2^o(t)), \dots, f'(a_n^o(t))] \quad (20)$$

$$h'(t) = \text{diag}[f'(a_1^h(t)), f'(a_2^h(t)), \dots, f'(a_m^h(t))] \quad (21)$$

where  $W^{h,i}(t)$  is the input weight matrix,  $W^{h,c}(t)$  is the context weight matrix and  $W^{o,h}(t)$  output weight matrix.

### 3.3 Feed Forward Neural Network (FFNN)

Feed Forward Neural Network (FFNN) (Moghaddam et al., 2016) transmits information from the inputs via the hidden layers to the outputs. Layers in the neural network, as well as the output layers, are related to input layers, each connection of layers are also associated with weight. The activation function (Moghaddam et al., 2016) of an  $i^{th}$  a hidden neuron is:

$$h_i = f(u_i) = f\left(\sum_{k=0}^K w_{ki} x_k\right) \quad (22)$$

where  $h_i$  is the  $i^{th}$  hidden neuron,  $f(u_i)$  is the link function which gives non-linearity among input and hidden layer,  $w_{ki}$  is the weight in the  $ki^{th}$  entry in a  $(K \times N)$  weight matrix,  $x_k$  is the K input value:

Figure 2. Structure of ELMAN neural network

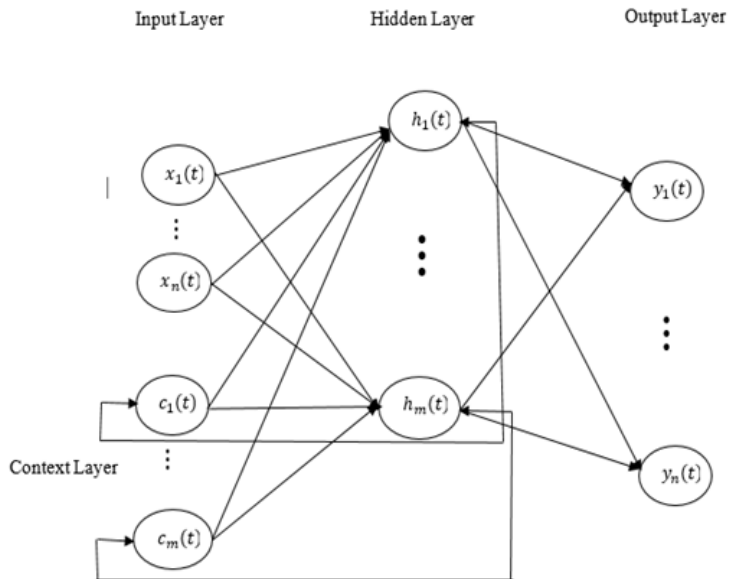

$$y_j = f(u_j^1) = f\left(\sum_{i=1}^N w_{ij} h_i\right) \quad (23)$$

where  $y_j$  is the  $j^{\text{th}}$  output value.

### 3.4 Cascade Forward Neural Network (CFNN)

Cascade forward neural network (CFNN) incorporates a weighted link from the input to every layer and then from each layer to the succeeding layers (Sibi et al., 2013). The CFNN model resembles FFNN in utilizing the backpropagation for updating the weights. In any case, the key relevance of CFNN is that each layer of neurons belongs to all past layers of neurons:

$$y = \sum_{i=1}^n f^i(w_i x_i) + f^o\left(\sum_{j=1}^K w_j^o f_j^h\left(\sum_{i=1}^n w_{ji}^h x_i\right)\right) \quad (24)$$

where  $f^i$  is the activation function,  $w_j^o$  is weight from the input layer to the output layer. In the event, a bias is added to the input layer and the activation function of each neuron in the hidden layer is  $f^h$  then Eq. (24) becomes:

$$y = \sum_{i=1}^n f^i(w_i x_i) + f^o\left(w^b + \sum_{j=1}^K w_j^o f_j^h\left(w_j^b + \sum_{i=1}^n w_{ji}^h x_i\right)\right) \quad (25)$$

### 3.5 Ensemble Deep Learning (EDL)

The study focuses on the design and implementation of ensemble deep learning algorithms, with a particular emphasis on Long Short Term Memory (LSTM), Elman Neural Network (ELMAN), Feed Forward Neural Network (FFNN), and Cascade Forward Neural Network (CFNN). LSTM, a specialized recurrent layer, sets itself apart by dividing the cell state into long-term and short-term components and utilizing three control gates (forget, input, and output gates) to manage the cell states. Elman networks incorporate context nodes that receive input from and transmit output to hidden nodes, enabling them to maintain state information among inputs. Feed Forward Neural Network (FFNN) and Cascade Forward Neural Network (CFNN) transmit information from inputs through hidden layers to outputs, with CFNN featuring weighted links from each input to every layer and from each layer to the subsequent ones.

The ensemble deep learning approach is adopted to harness the power of multiple base classifiers, including LSTM, ELMAN, FFNN, and CFNN, along with a random forest as the top layer. Each of these networks is trained using the respective training instances, and their predicted outputs are combined to produce the ensemble's final output. This ensemble strategy aims to enhance the overall performance by leveraging the diverse strengths of individual classifiers, resulting in improved prediction accuracy and robustness.

By utilizing the strengths of each deep neural network in the ensemble, the proposed framework seeks to achieve superior performance compared to using any single base classifier alone. Ensemble deep learning has been widely acknowledged for its ability to mitigate individual weaknesses and enhance overall predictive accuracy, making it a promising approach for various applications across different domains, including those involving time-series data or complex patterns. The combination of LSTM, ELMAN, FFNN, CFNN, and a random forest in the ensemble deep learning model allows for a comprehensive and diverse set of predictions, increasing the model's overall robustness and adaptability to various data scenarios as shown in Figure 3.

Figure 3. Schematic diagram of ensemble deep learning

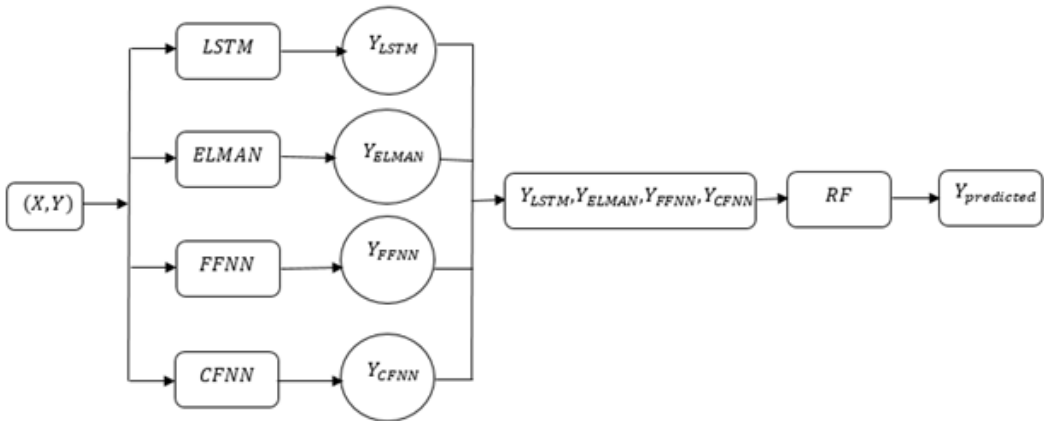

#### 4. RESULTS AND DISCUSSION

This section presents the experimental results of deep learning techniques such as long short term memory (LSTM), feed forward neural network (FFNN), cascade forward neural network (CFNN), Elman Neural Network (ELMAN) and the proposed ensemble deep learning (EDL) for diagnosis of cardiovascular disease. As stated earlier, we used data from the Kaggle database for cardiovascular disease. The data was segmented into a training set to train the model while other test data to test it. 60% of the data was used as training datasets while 40% was selected as test datasets. Classification of data includes two classes—namely, cardiovascular class consisting of 70,000 data including the cardiovascular class (34979 data) and non-cardiovascular class (35021 data). Table 2 is the cross tabulation of cardiovascular and non-cardiovascular disease.

From Table 2, gender group strength leans strongly towards women with a range of 64-65%. Most respondents are in the condition of both cardiovascular and non-cardiovascular diseases. Both patients of high Height and weight are in the condition of both cardiovascular and non-cardiovascular diseases. The result also indicated that most of the patients have high systolic blood pressure while some of the patients show both normal and high diastolic blood pressure. Most of the patients have a normal cholesterol level while most of the patients do not indulge in smoking and alcohol. The accuracy of these criteria: TP Rate (True Positive Rate), FP Rate (False Positive Rate), PPV (Predicted Positive Value), DR (Detection Rate) and DP (Detection Prevalence) to diagnose cardiovascular disease (see Table 3).

From the results of Table 3, Figure 4-8 shows the comparison of the accuracy of these criteria.

TP Rate, FP Rate, PPV, DR and DP. According to Figure 4, 6-8, the TP Rate, PPV, DR and DP accuracy belongs to proposed EDL with 100%, 200%, 50.05% and 50.05%, respectively, followed by CFNN, LSTM, ELMAN and FFNN, respectively.

According to the results in Table 4 and Figure 9, EDL has the highest accuracy of 100% for the cardiovascular disease diagnosis. Also, the classification accuracy of LSTM, FFNN, CFNN and ELMAN was at the range of 71% -73%, respectively. Based on Figure 9, LSTM, FFNN, CFNN and ELMAN have the least classification accuracy in the cardiovascular disease diagnosis. As shown in Table 5, the performance of our proposed EDL was compared to that of various current test partition classification techniques. Overall, the results demonstrate that separating the train and test in the ratios of 90:10, 80:20, and 60:40 outperforms splitting the train and test in the ratio of 70:30.

Table 2. Cross tabulation of cardiovascular and non-cardiovascular

Variables		Cardiovascular(%)	Non-Cardiovascular(%)
Gender	Women: 1	22616(64.7)	22914(65.4)
	Men: 2	12363(35.3)	12107(34.6)
Height	Low: 55-160	12020(34.4)	11525(32.9)
	High: 161-250	22959(65.6)	23496(67.1)
Weight	Low: 10-100	32730(93.6)	34019(97.1)
	High:101-200	2249(6.4)	1002(2.9)
Ap_hi	Low:-150-119	3094(8.8)	9944(28.4)
	Normal: 120-129mmHg	10072(28.8)	18216(52.0)
	High: 130-above	21813(62.4)	6861(19.6)
Ap_lo	Low:-70-79	4009(11.5)	10107(28.9)
	Normal: 80mmHg	14809(42.3)	20038(57.2)
	High: 81-above	16161(46.2)	4876(13.9)
Cholestrol	Normal: 1	23055(65.9)	29330(83.7)
	Above normal: 2	5750(16.4)	3799(10.8)
	Well above normal: 3	6174(17.7)	1892(5.4)
Glucose	Normal:1	28585(81.7)	30894(88.3)
	Above normal: 2	3078(8.8)	2112(6.0)
	Well above normal:3	3316(9.5)	2015(5.8)
Smoke	No smoke: 0	32050(91.6)	31781(90.7)
	Smoke: 1	2929(8.4)	3240(9.3)
Alcohol	No Alcohol: 0	33156(94.8)	33080(94.5)
	Alcohol: 1	1823(5.2)	1941(5.5)
Active	Not active: 0	7361(21.0)	6378(18.2)
	Active: 1	27618(79.0)	28643(81.8)

Table 3. The results of classification based on cardiovascular and non-cardiovascular disease

DLA	TP Rate	FP Rate	PPV	DR	DP
LSTM	67.40	23.80	73.95	33.74	45.62
FFNN	65.88	20.55	76.26	32.97	43.24
CFNN	68.16	22.95	74.85	34.12	45.58
ELMAN	66.18	20.69	76.22	33.12	43.46
EDL	100	0.00	100	50.05	50.05

## 5. CONCLUSION

This paper did not just investigate it proposed a novel technique of prediction of CVD utilizing an ensemble of classifiers. Kaggle Cardiovascular Dataset was utilized for training and testing purposes. We recommended an ensemble deep learning model for the medical diagnosis of CVD utilizing deep learning strategies. We analyzed different models utilizing cardiovascular data acquired from

Figure 4. Classification analysis based on the true positive rate (TP Rate) criteria for diagnosis of cardiovascular disease

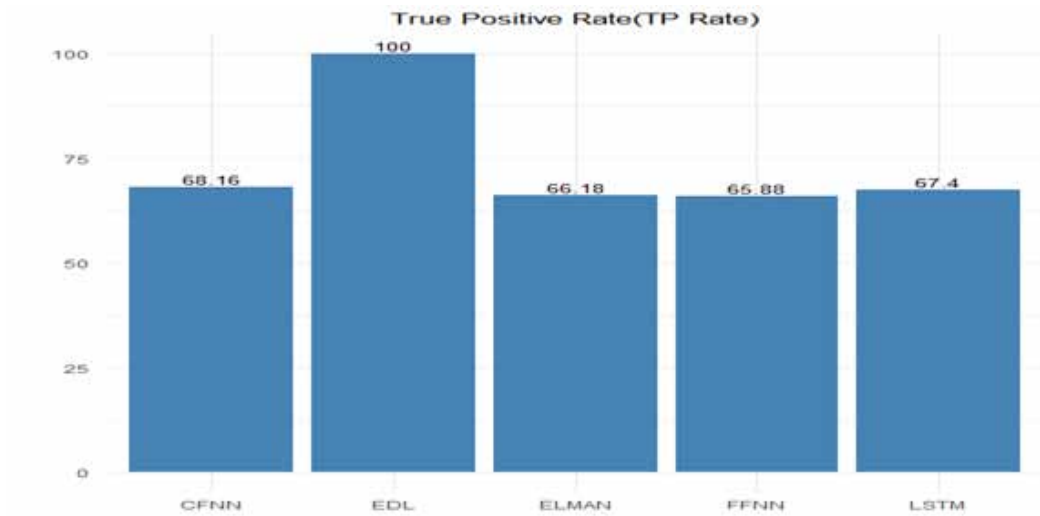
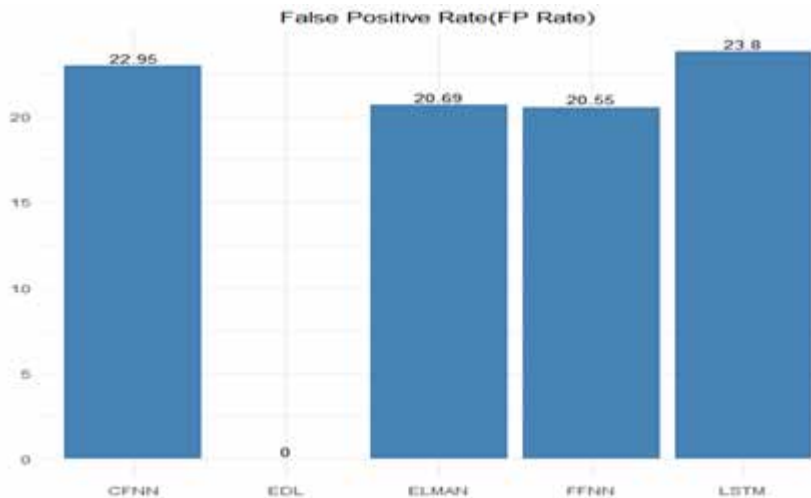

Figure 5. Classification analysis based on the false positive rate (FP Rate) criteria for diagnosis of cardiovascular disease



the Kaggle database. The highest TPR, FPR, PPV, DR, and DP values belong to EDL. Our proposed model is effective and precise in deciphering test results by building a technique to classify the patient and consequently analyze the CVD in a quick, and reasonable way, which improves the present clinical method.

In future research, we will consider a model with various deep learning algorithms for the top layer of an ensemble that can predict CVD more precisely. The model will be integrated into a wearable system (Girčys et al., 2020) that will serve as a part of the integrated e-health solution (Vanagas et al., 2018). One potential direction is to explore more sophisticated ensemble techniques, such as stacking or boosting, to combine the predictions of various base classifiers effectively. These advanced ensemble methods can enhance the model's performance by leveraging the strengths of

Figure 6. Classification analysis based on the positive predicted value (PPV) criteria for diagnosis of cardiovascular disease

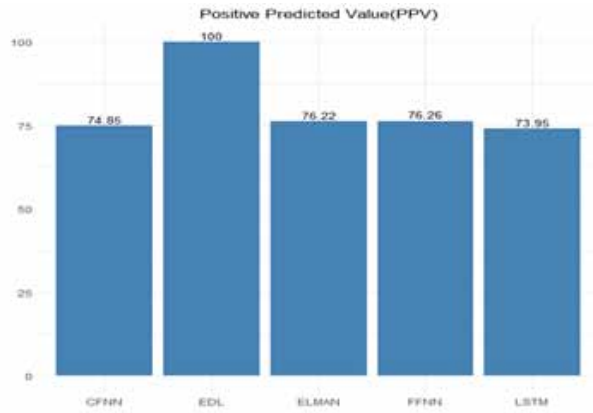

Figure 7. Classification analysis based on the detection rate (DR) criteria for diagnosis of cardiovascular disease

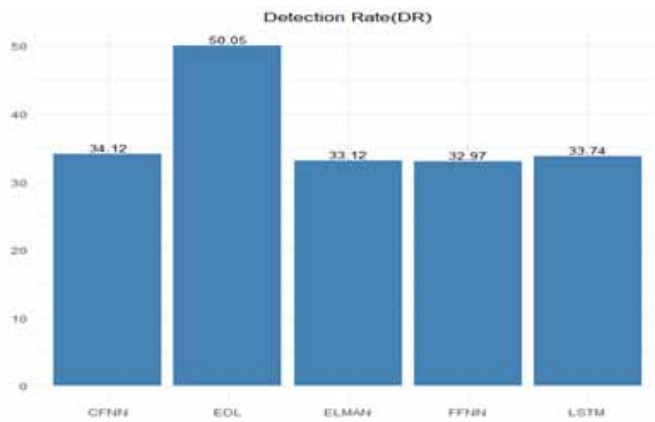

Figure 8. Classification analysis based on the detection prevalence (DP) criteria for diagnosis of cardiovascular disease

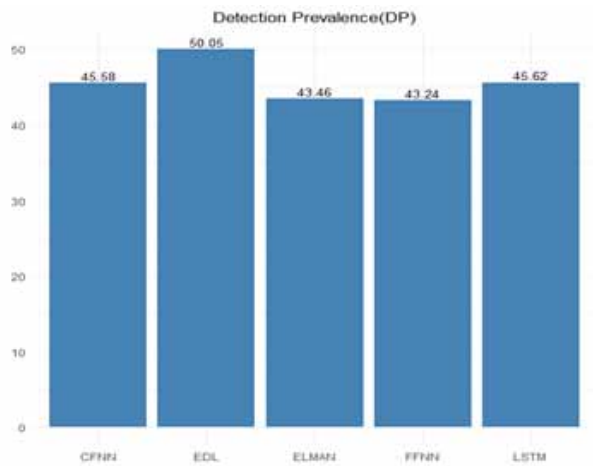



Table 4. Classification accuracy of cardiovascular disease

DLA	Correctly Classified (%)	Incorrectly Classified (%)
LSTM	71.8	28.2
FFNN	72.7	27.3
CFNN	72.6	27.4
ELMAN	72.74	27.26
EDL	100	0.00

Table 5. Performance evaluation of LSTM, FFNN, CFNN, ELMAN, EDL based on test partition

Model	Parameter	Train:Test			
		90:10	80:20	70:30	60:40
LSTM	TPRate	0.7123	0.7043	0.6523	0.6740
	FPRate	0.2521	0.2411	0.2401	0.2380
	PPV	0.7521	0.7121	0.7303	0.7395
	DR	0.3422	0.3402	0.3333	0.3374
	DP	0.4567	0.4523	0.4524	0.4562
FFNN	TPRate	0.6643	0.6621	0.6591	0.6588
	FPRate	0.2423	0.2324	0.2152	0.2055
	PPV	0.8124	0.7841	0.7435	0.7626
	DR	0.3561	0.3423	0.3243	0.3297
	DP	0.4422	0.4401	0.4201	0.4324
CFNN	TPRate	0.7014	0.6924	0.6526	0.6816
	FPRate	0.2344	0.2330	0.2242	0.2295
	PPV	0.7541	0.7511	0.7501	0.7485
	DR	0.3523	0.3425	0.3368	0.3412
	DP	0.5523	0.4784	0.4623	0.4558
ELMAN	TPRate	0.6984	0.6824	0.6523	0.6618
	FPRate	0.2232	0.2281	0.2103	0.2061
	PPV	0.8235	0.8143	0.8011	0.7622
	DR	0.4311	0.4123	0.3923	0.3312
	DP	0.4567	0.4423	0.4241	0.4346
EDL	TPRate	0.9857	0.9834	0.9745	0.9789
	FPRate	0.0361	0.0353	0.0236	0.0245
	PPV	0.9956	0.9921	0.9821	0.9854
	DR	0.9693	0.9542	0.9541	0.9465
	DP	0.9693	0.9685	0.9683	0.9683

Figure 9. Comparison of classification accuracy

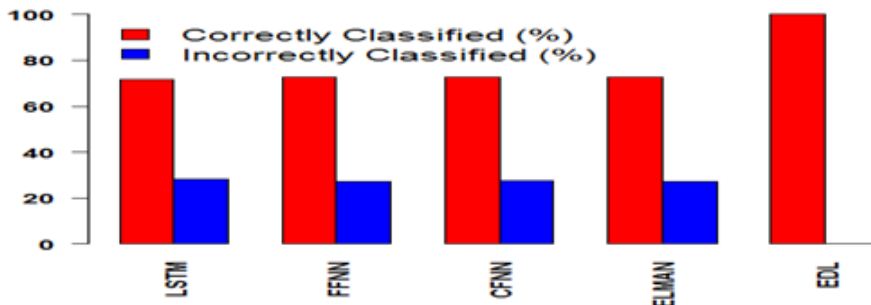

each individual classifier and further reducing the risk of overfitting. Additionally, integrating more diverse and comprehensive data sources into the model can enhance its predictive capabilities. For example, incorporating genetic data, lifestyle information, and real-time physiological measurements from wearable devices can provide a more holistic view of patients' health status. By integrating wearable systems into the e-health solution, continuous monitoring of cardiovascular health can be achieved, allowing for early detection of anomalies and timely interventions. To improve the model's generalizability and robustness, cross-validation techniques and transfer learning can be explored. Cross-validation can help in assessing the model's performance on various subsets of the data, providing insights into its stability and potential weaknesses. Transfer learning, on the other hand, enables the model to leverage knowledge from related tasks or datasets, which can be particularly useful when dealing with limited medical data. Moreover, the ensemble optimization deep learning model can be integrated into electronic health records (EHR) systems, supporting healthcare professionals in making more accurate diagnoses and treatment decisions. By seamlessly incorporating the model's predictions into clinical workflows, physicians can receive timely alerts for high-risk patients, enabling them to prioritize interventions and improve patient outcomes.

## REFERENCES

- Aarthy, S. T., & Iqbal, J. M. (2023). Modified parametric-based AlexNet structure to classify ECG signals for cardiovascular diseases. *Measurement. Sensors*, 27, 100816. doi:10.1016/j.measen.2023.100816
- Alaa, A. M., Bolton, T., Di Angelantonio, E., Rudd, J. H. F., & van der Schaar, M. (2019). Cardiovascular disease risk prediction using automated machine learning: A prospective study of 423,604 UK Biobank participants. *PLoS One*, 14(5), e0213653. doi:10.1371/journal.pone.0213653 PMID:31091238
- Ali, K. (2013). *Heart beat classification using particle swarm optimization*. *Intell. Syst. Appl.*
- Budhani, N., Jha, C. K., & Budhani, S. K. (2014). Prediction of stock market using artificial neural network," *Proc. of International Conference on Soft Computing Techniques for Engineering and Technology (ICSCTET)*, (pp. 1-8). doi:10.1109/ICSCTET.2015.7371196
- Calisto, F. M., Ferreira, A., Nascimento, J. C., & Gonçalves, D. (2017, October). Towards touch-based medical image diagnosis annotation. In *Proceedings of the 2017 ACM International Conference on Interactive Surfaces and Spaces* (pp. 390-395). ACM. doi:10.1145/3132272.3134111
- Calisto, F. M., Santiago, C., Nunes, N., & Nascimento, J. C. (2022). BreastScreening-AI: Evaluating medical intelligent agents for human-AI interactions. *Artificial Intelligence in Medicine*, 127, 102285. doi:10.1016/j.artmed.2022.102285 PMID:35430044
- Kaggle. (n.d.). *Cardiovascular Disease dataset*. [Dataset]. Kaggle. <https://www.kaggle.com/sulianova/cardiovascular-disease-dataset>
- Fida, B., Nazir, M., Naveed, N., & Akram, S. (2011). Heart disease classification ensemble optimization using genetic algorithm. *IEEE 14th International Multitopic Conference*, (pp. 19-24). IEEE. doi:10.1109/INMIC.2011.6151471
- G'arate-Escamila, A., Hajjam El Hassani, A., & Andr'es, E. (2020). Classification models for heart disease prediction using feature selection and PCA. *Informatics in Medicine Unlocked*, 19, 100330. doi:10.1016/j.imu.2020.100330
- Gao, X., Amin Ali, A., Shaban Hassan, H., & Anwar, E. (2021). Improving the accuracy for analyzing heart diseases prediction based on the ensemble method. *Complexity*, 2021, 1–10. doi:10.1155/2021/6663455
- Geetha Devi, A. (2021). A method of cardiovascular disease prediction using machine learning. *Int J Eng Res Technol*, 9(5), 243–6.
- Gersh, B. J., Sliwa, K., Mayosi, B. M., & Yusuf, S. (2010). Novel therapeutic concepts: the epidemic of cardiovascular dis-ease in the developing world: global implications. *European Heart Journal*, 31(6), 642–648. doi:10.1093/eurheartj/ehq030 PMID:20176800
- Girčys, R., Kazanavičius, E., Maskeliūnas, R., Damaševičius, R., & Woźniak, M. (2020). Wearable system for real-time monitoring of hemodynamic parameters: Implementation and evaluation. *Biomedical Signal Processing and Control*, 59, 59. doi:10.1016/j.bspc.2020.101873
- Guanghua, R., Yuting, C., Shiping, W., Tingwen, H., & Zhigang, Z. (2018). A Modified Elman Neural Network with a New Learning Rate Scheme. *Neurocomputing*, 1–9.
- Haq, A. U., Li, J. P., Memon, M. H., Nazir, S., & Sun, R. (2018). A hybrid intelligent system framework for the prediction of heart disease using machine learning algorithms. *Mobile Information Systems*, 2018, 2018. doi:10.1155/2018/3860146
- Jafari, M., Shoeibi, A., Khodatars, M., Ghassemi, N., Moridian, P., Alizadehsani, R., Khosravi, A., Ling, S. H., Delfan, N., Zhang, Y.-D., Wang, S.-H., Gorriz, J. M., Alinejad-Rokny, H., & Acharya, U. R. (2023). Automated diagnosis of cardiovascular diseases from cardiac magnetic resonance imaging using deep learning models: A review. *Computers in Biology and Medicine*, 160, 106998. doi:10.1016/j.combiomed.2023.106998 PMID:37182422
- Javeed, A., Zhou S., Yongjian, L., Qasim, I., Noor, A., & Nour, R. (2019). An intelligent learning system based on random search algorithm and optimized random forest model for improved heart disease detection. *IEEE Access* 2019;7(7):180235–43. . November.10.1109/ACCESS.2019.2952107

- Lauraitis, A., Maskeliunas, R., Damasevicius, R., Polap, D., & Wozniak, M. (2019). A smartphone application for automated decision support in cognitive task based evaluation of central nervous system motor disorders. *IEEE Journal of Biomedical and Health Informatics*, 23(5), 1865–1876. doi:10.1109/JBHI.2019.2891729 PMID:30629520
- Li, R., Shen, S., Chen, G., Xie, T., Ji, S., Zhou, B., & Wang, Z. (2019). Multilevel Risk Prediction of Cardiovascular Disease based on Adaboost+ RF Ensemble Learning. *IOP Conference Series. Materials Science and Engineering*, 533(1), 012050. doi:10.1088/1757-899X/533/1/012050
- Louridi, N., Amar, M., & El Ouahidi, B. (2019). Identification OF cardiovascular diseases using machine learning. In: *7th mediterranean congress of telecommunications (CMT)*. (pp. 24–5) IEEE. . doi:10.1109/CMT.2019.8931411
- Mackay, J., & Mensah, G. (2004). *Atlas of heart disease and stroke*.
- Miao, K. H., & Miao, J. H. (2018). Coronary heart disease diagnosis using deep neural networks. *International Journal of Advanced Computer Science and Applications*, 9(10), 1–8. doi:10.14569/IJACSA.2018.091001
- Mienye, I., Sun, Y., & Wang, Z. (2020). An improved ensemble learning approach for the prediction of heart disease risk. *Informatics in Medicine Unlocked*, 20, 100402. doi:10.1016/j.imu.2020.100402
- Moghaddam, A. H., Moein, H. M., & Morteza, E. (2016). Stock market index prediction using artificial neural network. *Journal of Economics, Finance and Administrative Science*, 21(41), 89–93. doi:10.1016/j.jefas.2016.07.002
- Naghavi, M., Abajobir, A. A., Abbafati, C., Abbas, K. M., Abd-Allah, F., Abera, S. F., Aboyans, V., Adetokunboh, O., Afshin, A., Agrawal, A., Ahmadi, A., Ahmed, M. B., Aichour, A. N., Aichour, M. T. E., Aichour, I., Aiyar, S., Alahdab, F., Al-Aly, Z., Alam, K., & Murray, C. J. L. (2017). Global, regional, and national age-sex specific mortality for 264 causes of death, 1980–2016: A systematic analysis for the Global Burden of Disease Study 2016. *Lancet*, 390(10100), 1151–1210. doi:10.1016/S0140-6736(17)32152-9 PMID:28919116
- Nawaz, M. S., Shoaib, B., & Ashraf, M. A. (2021). Intelligent Cardiovascular Disease Prediction Empowered with Gradient Descent Optimization. *Heliyon*, 7(5), e06948. doi:10.1016/j.heliyon.2021.e06948 PMID:34013084
- Naz, M., Shah, J. H., Khan, M. A., Sharif, M., Raza, M., & Damaševičius, R. (2021). From ECG signals to images: A transformation based approach for deep learning. *PeerJ. Computer Science*, 7, 1–18. doi:10.7717/peerj-cs.386 PMID:33817032
- Patil, S. B., & Kumaraswamy, Y. S. (2009). Extraction of significant patterns from heart disease warehouses for heart attack prediction. *Int. J. Comput. Sci. Netw. Secur*, 9(2), 228–235.
- Šalkevicius, J., Damaševičius, R., Maskeliunas, R., & Laukienė, I. (2019). Anxiety level recognition for virtual reality therapy system using physiological signals. *Electronics (Basel)*, 8(9), 1039. doi:10.3390/electronics8091039
- Sibi, P., Jones, S. A., & Siddarth, P. (2013). Analysis of different activation functions using back propagation neural networks. *Journal of Theoretical and Applied Information Technology*, 47(3), 1264–1268.
- Sudhakar, K. (2014). Study of heart disease prediction using data mining. *International Journal of Advanced Research in Computer Science and Software Engineering*, 4(1), 1157–1160.
- Thomas, H., Diamond, J., Vieco, A., Chaudhuri, S., Shinnar, E., Cromer, S., Perel, P., Mensah, G. A., Narula, J., Johnson, C. O., Roth, G. A., & Moran, A. E. (2018). Global atlas of cardiovascular disease 2000-2016: The path to prevention and control. *Global Heart*, 13(3), 143–163. doi:10.1016/j.ghheart.2018.09.511 PMID:30301680
- Tseng, R. M. W. W., Rim, T. H., Shantsila, E., Yi, J. K., Park, S., Kim, S. S., Lee, C. J., Thakur, S., Nusinovici, S., Peng, Q., Kim, H., Lee, G., Yu, M., Tham, Y.-C., Bakhai, A., Leeson, P., Lip, G. Y. H., Wong, T. Y., & Cheng, C. Y. (2023). Validation of a deep-learning-based retinal biomarker (Reti-CVD) in the prediction of cardiovascular disease: Data from UK Biobank. *BMC Medicine*, 21(1), 1–10. doi:10.1186/s12916-022-02684-8 PMID:36691041
- Uddin, M. N., & Halder, R. K. (2021). An ensemble method based multilayer dynamic system to predict cardiovascular disease using machine learning approach. *Informatics in Medicine Unlocked*, 24, 100584. doi:10.1016/j.imu.2021.100584
- Vanagas, G., Engelbrecht, R., Damaševičius, R., Suomi, R., & Solanas, A. (2018). EHealth solutions for the integrated healthcare. *Journal of Healthcare Engineering*. PMID:30123441

Vanisree, K. (2011). Decision support system for congenital heart disease diagnosis based on signs and symptoms using neural networks. *International Journal of Computer Applications*, 19(6), 612. doi:10.5120/2368-3115

Vasighi, M., Ali Zahraei, B. S., & Vafaeimanesh, J. (2013). *Diagnosis of coronary heart disease based on Hnmr spectra of human blood plasma using genetic algorithm-based feature selection*. Wiley Online.

Wu, J., Wei, W., Zhang, L., Wang, J., Damasevicius, R., Li, J., & Wozniak, M. (2019). Risk assessment of hypertension in steel workers based on LVQ and fisher-SVM deep excavation. *IEEE Access : Practical Innovations, Open Solutions*, 7, 23109–23119. doi:10.1109/ACCESS.2019.2899625

Wu, Y., Benjamin, E. J., & MacMahon, S. (2016). Prevention and control of cardiovascular disease in the rapidly changing economy of China. *Circulation*, 133(24), 2545–2560. doi:10.1161/CIRCULATIONAHA.115.008728 PMID:27297347

Xing, Y., Wang, J., & Zhao, Z. (2007). Combination data mining methods with new medical data to predicting outcome of coronary heart disease. In *International Conference on Convergence Information Technology (ICCIT 2007)*, (pp. 868-872). IEEE. doi:10.1109/ICCIT.2007.204

Yu, B., Chen, H., Jia, C., Zhou, H., Cong, L., Li, X., Zhuang, J., & Cong, X. (2023). Multi-modality multi-scale cardiovascular disease subtypes classification using Raman image and medical history. *Expert Systems with Applications*, 224, 119965. doi:10.1016/j.eswa.2023.119965

Zhang, D., Liu, X., Xia, J., Gao, Z., Zhang, H., & de Albuquerque, V. H. C. (2023). A physics-guided deep learning approach for functional assessment of cardiovascular disease in IoT-based smart health. *IEEE Internet of Things Journal*, 10(21), 18505–18516. doi:10.1109/JIOT.2023.3240536

*David Opeoluwa Oyewola holds excellent qualifying undergraduate, master's and doctoral degrees in Mathematics, Financial Mathematics and Applied Mathematics respectively. He has worked with many colleagues nationally and internationally who have substantial knowledge of computing, artificial intelligence, management, numerical sciences, and python programming language with special interest in the application of such knowledge to develop cutting edge IT innovations, data analysis. He has published over 50 articles in international and local journals, conferences, and book chapters.*

*Emmanuel Gbenga DADA is an Associate Professor of Computer Science. He received his PhD in Computer Science from Universiti Malaya, Malaysia (UM), MSc in Computer Science from University of Ibadan, Ibadan (UI), Nigeria and a Bachelor of Technology in Computer Science from the University of Ilorin, Ilorin, Nigeria. His current research interests are in Softcomputing Techniques and Machine Learning Algorithms with their application to Cyber Security, Medical Imaging, COVID-19 detection, diagnosis, Surveillance, and other areas of application. He has published about 100 academic papers in reputable International and local journals, conference proceedings and book chapters. He has been appointed as a reviewer of several ISI and Scopus Cited Publication International journals such as ACM Survey, IEEE Access, Lecture Notes in Computational Vision and Biomechanics. He is a member of IEEE, International Society for Knowledge Organization (ISOK-WA), International Association of Engineers (IAENG) and Computer Professionals Registration Council of Nigeria (CPN).*

*Sanjay Misra, a Sr. member of IEEE and ACM Distinguished Lecturer, is a Senior Scientist at the Institute of Energy Technology (IFE), Halden, Norway. Before joining IFE, he was associated with the Computer Science and Communication department of Østfold University College, Halden, Norway, and was a Full Professor (since Jan 2010) of Computer (Software) Engineering at Covenant University (400-500 ranked by THE (2019)) since 2012 yrs. He holds PhD. in Information & Knowledge Engg (Software Engg) from the University of Alcalá, Spain & M.Tech. (Software Engg) from MLN National Institute of Tech, India. As per SciVal (SCOPUS- Elsevier) analysis (on 01.12.2021). He has been the most productive researcher (Number 1) in Nigeria since 2017 (in all disciplines), in computer science no 1 in the country & no 2 in the whole of Africa. Total around 700 articles (SCOPUS/WoS) with 500 coauthors worldwide (-130 JCR/SCIE) in the core & appl. area of Software Engineering, Web engineering, Health Informatics, Cybersecurity, Intelligent systems, AI, etc. He has been amongst the top 2% of scientists in the world (published by Stanford University) for last 3 years.*