

IoT-Based Intelligent Irrigation System for Paddy Crop Using an Internet-Controlled Water Pump

Brij Bhushan Sharma, Shoolini University of Biotechnology and Management Sciences, Solan, India
Nagesh Kumar, Shoolini University of Biotechnology and Management Sciences, Solan, India

ABSTRACT

IoT is a communal association of things or equipment that can interact with each other with the help of an internet connection. IoT services play an imperative responsibility in the industry of agriculture, which can feed 10 billion people worldwide by 2050. Irrigation systems are a backbone of agriculture that help to reduce wastage of water and decide the effective usage of water according to the specific crop and thereby increase the crop yield. In this paper, an irrigation system is developed to supervise the paddy crop field using sensors (soil moisture sensor, pH sensor, and flow sensor), and this irrigation system works based on the concept of IoT, so it is known as intelligent irrigation system (IIS). The soil condition data from sensors are sent to a web server database using wireless transmission to decide how much water needed. In the proposed server database, the data is saved, and the authors use the concept of a dashboard; it operates via http protocol to control water pump of farmland. The condition of soil is monitored based on the parameter of soil-like moisture and water flow amount using the IoT, which is capable to turn on/off water pumps. The used dashboard is developed using open source free server, namely “000webhost.” This paper has considered the paddy crop that is rice because water is essential for growth and development of rice plants. The experimental results show this system is more proficient than the existing conventional and unadventurous irrigation approach.

KEYWORDS

Agriculture, Communicating Network, Intelligent Irrigation System, Internet of Things (IoT), Remote Monitoring, Sensor

1. INTRODUCTION

Agriculture is considered as the foundation of human life and only resource of food granule. In the agriculture field, innovative tools emerge, bringing automated, unremitting, and spontaneous features for communication through internet applications (Sharma & Kumar, 2020). It also provides a large number of employment opportunities to the nation’s population. By implementing an intelligent and automated system in irrigation and using advanced automatic machines, the field has been improved compared to the conventional methods. In this research, automated irrigation control system is developed which can regulate the water supply with the internet through IoT communication system. Also, with this system, the status of paddy crop filed can be monitored from any location. Irrigation of paddy crops is one of the significant issues found in agriculture, mostly in developing countries. There are varieties of conventional paddy crop irrigation systems that have been followed from ancient times. For illustration, in a flow-based irrigation system, the water resources like tanks or

DOI: 10.4018/IJAEIS.20210101.oa2

This article, published as an Open Access article on February 26th, 2021 in the gold Open Access journal, the International Journal of Agricultural and Environmental Information Systems (converted to gold Open Access January 1st, 2021), is distributed under the terms of the Creative Commons Attribution License (<http://creativecommons.org/licenses/by/4.0/>) which permits unrestricted use, distribution, and production in any medium, provided the author of the original work and original publication source are properly credited.

reservoirs are positioned at great heights. The flow of water is automatically downward when it is connected to the tank or reservoir. Those categories of irrigation are regularly used and beneficial in open areas. The other category of irrigation is lift-irrigation, where the crop fields are situated at a higher level than the water resources (Rasooli, Bhushan, & Kumar, 2020). The crop field is irrigated by lifting aqua from wells, tanks, canals, rivers using electrical water pumps. At present, the underground water is also pumped to irrigate the crop field using electrical water pumps. To improve conventional irrigation methods, there have been many irrigation systems developed using advanced and intelligent technologies that help to reduce crop wastes, prevent excessive and scarce watering to crops, and thereby increase the crop yield. This problem can be eliminated if farmers use an automatic and intelligent irrigation system using sensors based IoT communication system. For example, IoT communication systems can be used to monitor environmental parameters through soil nutrition which can help in to predict the quality as well as the plant growth. IoT is helpful in the estimation of the required amount of irrigation using the parameters like pH, moisture weather monitoring and temperature of soil (Bhatt, Bhushan, & Kumar, 2019), and the architecture of Automated Irrigation System with IoT using the idea of the dashboard is shown in Figure 1.

In Figure 1 the utilization of the IoT communication system for agriculture were shown. The sensor nodes represented by green circles were deployed in the field. Communication process in between each sensor is achieved via Wireless links. User can remotely handle and monitor these sensor nodes via laptops or mobile phones. For e.g. in this paper if the water level rises above the set limit user can switch off the pump through his/her mobile phone. The designed IIS experimented on the paddy crop (rice) because enough supply of water is essential for the growth and development of rice plants. This paper focused on unlike factors to be determined for rice crops (Kumar & Sharma, 2020). So, farmers should be independent to monitor via installing a smart system. It could be possible when the prototype is converted into product and distributed among farmers via giving proper knowledge of our product. In this research, the irrigation system is designed for the paddy crop, and in Figure 2, the paddy crop is shown.

Paddy crop is powerfully predisposed by water supply. Water should be kept standing in the field throughout the growth period. The characteristics of flooded soil which useful for rice are:

- Rice plant is a semi-aquatic plant that requires near submergence.

Figure 1. Architecture of IoT based Intelligent Irrigation System

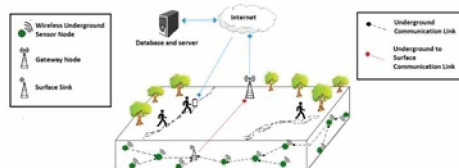

Figure 2. Paddy Crop in India



- Submergence for rice crop helps in suppressing weed growth and more availability of specific nutrients.
- Daily water consumptive use of rice crop is 6 to 10mm.
- The total amount of water requirement for rice crop is 1200 to 1400 mm.
- To produced 1kg of rice, 2000 - 3000 liters of water required.
- Highly saline and brackish water not suitable for rice crop irrigation.
- Maintenance of water level and their depths in the field of rice necessary factors to produce maximum rice.

Figure 3 and Table 1 represents the requirement of water for rice crop concerning growth stages where the pH value of the soil is in the range of 6.5 to 8.5. Based on this requirements list, an IIS is designed for rice crops using the concept of IoT to control the water pump automatically. In this paper, we implemented a system for IIS based on IoT, and our contribution to this research follows:

- Design an IoT based model for irrigation control system by monitoring soil pH value, moisture, and temperature, etc.
- The model is designed for rice crops where sensor nodes are deployed in the rice field to monitor a water level and crop health.

Table 1. Requirement of water for rice crop concerning growth stages

Stages of rice growth	pH Value	Avg. water requirement (mm)	% of the total water requirement (Approx.)
Nursery	6.5-8.5	50-60	5
Main field preparation	6.5-8.5	200-250	20
Planting to Panicle initiation (PI)	6.5-8.5	400-550	40
P.I to flowering	6.5-8.5	400-450	30
flowering to maturity	6.5-8.5	100-150	5
Total		1200-1460	100.0

Figure 3. Rice Water Requirements

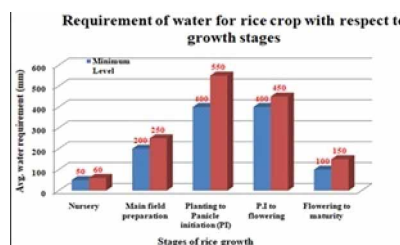

This paper presents the design and implementation procedure of an IIS for paddy crop monitoring using IoT communication to control the water pump via the internet. Specifically, in Section 2, we present the background survey of existing technologies for the IoT based irrigation systems. The

proposed system is presented in Section 3. The result of the proposed system is covered in Section 4, and we conclude with discussions on current challenges and future trends in Section 5.

2. LITERATURE SURVEY

The survey of existing work based on the advanced irrigation system using different techniques and mechanisms is presented in this section. (Sharma & Kumar, 2020) We must upgrade the flexibility and comfort of the new sharp residence system by beating the issue of user controls of wired devices in agribusiness by using a remote correspondence module. Regardless, since the current advancement measurement of the remote correspondence structure encounters a power-need issue, the progression of the low-power remote correspondence module is being authorized, and with the improvement of the battery advancement, the change speed from the wired structure to the remote system (Rasooli et al., 2020). In 2020 field of agriculture can be developed with the use of Wireless Sensor Networks (WSN) & IoT. Parameters like the quality of soil, growth of the plant/crop required amount of temperature for crops, irrigation water quality and quantity can be maintained easily with the help of systems developed with the use of IoT and WSN. (Bhatt et al., 2019) in this paper authors have introduced a common data on the utilization of WSN utilizing different sensors nodes and node hubs accessible for keen agribusiness. Still, in numerous pieces of the world, individuals do not know about WSN, which can be helpful for them in the upgraded generation of harvests utilizing least assets. The checking of the fields, identification of ecological conditions, and the computerized water system/trickling framework utilizing WSN are high in need to improve the farming framework. It is inferred that with such many focal points of WSN, there is more need for WSN in the part of horticulture. More advancements can, in any case, be made in WSN to make more progress in brilliant agribusiness. (Kumar & Sharma, 2020) in the authors of this paper presented various opportunities and challenges available in smart technologies they stated that Internet of things involved in agricultural machinery, can correctly be utilized to maintain the farming fields, farmers can invest in digitalization techniques for the treatment of the plant. IoT provides farmers a useful platform to exchange useful information. This communication system can play a vital role in the advancement of the techniques (Barkunan, Bhanumathi, & Sethuram, 2019), had designed a smart sensor for automatic drip smart irrigation system for paddy crop growing. They proposed computerization of a dribble water system in which the shrewd cell phone at first catches soil picture, ascertains its wetness level, and transmits the information onto the microcontroller through the GSM module discontinuously. The microcontroller chooses the water system and sends the status of the field to the Farmer's cell phone. The framework is tried for paddy field for over a time of a quarter of a year. It is seen from the test arrangement, that it spares about 41.5% and 13% of water contrasted with the traditional flood and trickle water system techniques separately. (Li, Jinmao & Hu He, 2019) had the Design of rice intelligent water-saving irrigation systems based on agricultural internet of things. They plan a model with information transmission is performed by GPRS. The autonomous GPRS terminal hub is structured. The control hub is inserted into the gulf gadget, which improves the system adaptability of the framework and the soundness and consistent execution of information transmission among equipment and programming frameworks. The arrangement of GPRS remote system innovation is given, which rearranges the plan of a wide range of hubs in the framework. The data trade framework, terminal observing hardware gathering, and repository control framework are structured in detail. The framework gathers genetic data, for example, water level tallness, soil dampness, soil manure, crop stature, field photographs, etc. continuously, and alters the developing condition of rice progressively controlling the relating gear as per the need. Cause rice to develop in the best condition; advance the solid development of rice. The assembled data can be utilized for specific association examination, resemblance, and information combination, and can likewise give the premise to logical cultivating. With the presentation of the application and page remote control conspire, the capacity of the rice programmed water system framework has been recently improved, and the practicability of the framework has been upgraded.

(L Kamelia, M A Ramdhani, A Faroqi & V Rifadiapriyana 2018) presented a system to implement an automated system for monitoring the requirement of humidity and irrigation of soil. A model is proposed having soil moisture sensor (YL-69) with MCU ESP8266 to automate the sprinklers, the measurands were displayed on LCD display and with the use of the ESP8266 Wi-Fi module same real time monitored data can be displayed online. Results of their system have shown that response time is of 1.29 sec. (R. Nageswara Rao & B.Sridhar, 2018) Proposed a system based on an IoT the monitoring of crop-fields and for the automation of the irrigation system. The proposed system is created on the data received from the sensor and gauge the required water amount. In the proposed system sensors (two) are utilized to fetch the information regarding the stickiness, temperature of the dirt, dampness, temperature, and the daylight span every day and then to transmit it to BS (base station). System implemented by the authors relies on these parameters and calculates the requirement of the water. This exploration work proposed and assessed a cloud-based remote correspondence framework to screen and control the sensors and actuators to have the proper calculation of the water requirement by the plant. Depending upon the survey, we can make conclusion that following are some important points to have the proper knowledge of the existing problems.

2.1. Problem Statement

- Existing irrigation systems are unable to decide how much water required for rice crop according to the growth stages of the rice plant.
- Power utilization is another problem. Water pumps uses diesel or electricity.
- Existing system cannot predict the period of water pump should turn on/off due to lack of fast internet services.

Going for lack of the above framework, the paper plans a smart water-sparing water system framework for rice-dependent on the farming IoT. The framework centers around the development of a remote sensor organize and the plan of equipment and programming. The sensors and control units legitimately report the checking information to the internet server through IoT systematize, to maintain a strategic distance from the hazard that the framework cannot effectively identify the rice data because of the loss of motion of a transfer station or organizer. The internet server is responsible for information examination, grouping, mix, and calamity forecast. Moreover, the remote constant checking of paddy field condition is acknowledged, and the ranchers are kept educated regarding the observing data as an application or site page. Push pertinent data on the water system, bug control, and manure, and guide ranchers to oversee rice fields logically. In this paper we have provided the solution to solve the above problems and presented and design a model that can be helpful in many other problems and reduce the wastage of water with low power consumption. (Gondchawar & Kawitkar, 2016) proposed a smart irrigation system using an LM35 Temperature sensor, Humidity Sensor DHT11, Obstacle avoiding or Ultrasonic sensor and Moisture sensor to build a smart irrigation system with the help of paring this sensor device with the Raspberry PI, for the communication purposes in between the devices they have used ZigBee module. After implementing the author of this system observed from the experimental results that the system is providing a complete solution to the following problems:

- Irrigation problems
- Storage problems
- Warehouse managements

They have used a remotely controlled robot to achieve the solution. (Muangprathub et al., 2019) to improve quality and crop yields with fewer investment IoTs can be applied in agriculture. Authors proposed Wireless sensor networks-based application for the irrigation of the crops. The system was designed and implemented for controlling the environmental parameters in the fields. Their system was divided into three parts:

- Hardware
- Web Application
- Mobile Application

The hardware part is designed as the main control box for the whole process, which includes the hardware and the electronic unit. This unit is responsible for the communication and control of all sensor units for data gathering and transmission of collected data from the crops. The web-based application is designed and implemented to manipulate the data. This data is useful for climate and environment controls. In the end, they concluded that a suitable temperature for high productivity is between 29°C to 32°C. (Saraf & Gawali, 2017) the proposed system is the automated irrigation system that is developed with the integration of the system with the cloud. This system can be applied to agriculture applications. The study and analysis of the presented system showed that this system could manage irrigation water supply with more effectiveness. Less water consumption is achieved. The system is soil-moisture based automated irrigation. Table 2 shown shows the various irrigation system developed using IoT.

3. PROPOSED METHODOLOGY

The proposed system for the monitoring of Rice Crop using Internet of Things consists of several steps. The block diagram shown below represents the proposed system in Figure 4.

Figure 4 represents the block diagram of designed IIS with used components and services. The overall setup of the designed model using Arduino, Node-MCU, IoT network, sensors, solar panel, ware pump, and screen to display the results and instructions. Using the concept of IoT, farmers can switch on or switch off from anywhere. Connectivity to the system will be provided through Internet Hotspot or Wi-Fi with the help of ESP8266. Secondly, farmers can easily monitor the amount of water, and based on the data received from the field farmers can switch on or switch off the water pump using the mobile phone and laptop-based instructions. Circuit diagram of the proposed system intelligent irrigation system is shown in Figure 5, which is designed for the rice crop. Circuit diagram of the proposed system can be explained as:

- In this proposed system, technology based on IoT is used. Parameter like flow of water in ml and soil moisture content can be measured.
- The output pin of the flow sensor is connected to Arduino's digital pin (pin no 2). All the data fetched by the flow sensor is transmitted to the Arduino Uno. Then Arduino Uno transmits this data for further process to the Node MCU ESP8266 using the serial communication pins of (RX, TX) of Arduino and node MCU.
- Soil moisture sensor provides the Analog output which connected to the Node MCU using the ADC pin (A0).
- Water pump used for the irrigation is connected through relay module to Node MCU using the digital pin D0.
- pH sensor connected to the Node MCU and pH values were determined.
- All sensor connected to the system fetches data and this data is then gathered at Node MCU from where it is transmitted to the server.
- As irrigation process starts, data regarding the flow of water will be calculated say 1000ml and at the same time soil moisture content is also considered say 0%. This data will be sent to the server.
- With these parameters, data received at the server will let the user know the status of the water-pump whether on or off.
- Threshold value is set for the water flow 1000.

Table 2. Various irrigation system developed using IoT

Author	Paper Title	Paper Description
Joaquín Gutiérrez et al. (A. Deshpande & Prasad, 2015)	Automated Irrigation System Using a Wireless Sensor Network and GPRS Module.	In the proposed system it consists of WSN and WIU that allows the transfer of soil moisture and temperature data. WSN is responsible for the all sensing challenges whereas WIU is used for the data transmission through GPRS module to web page for the analysis purposes. This irrigation system allows cultivation in places where the availability of water is very less. The information can be remotely monitored online through a graphical application. Photovoltaic panels have powered the entire system.
Amandeep et al. (Basu & Ghosh, 2016)	Smart Farming Using IoT.	The system consists of two blocks that are connected to a central PC. Block 1 consists of a GPS vehicle, while block 2 consists of the warehouse part. Proper use of water has been done so that to eliminate the water wastage. These processes are included after harvesting. Storage and security of crops in the warehouse have also been taken care of. The warehouse consisting of room heater and cooling fan to maintain the parameters like temperature inside. A water pump is also introduced to maintain the proper level of the moisture content in soil. Warehouses are protected by using ultrasonic sensor which works on the principle of obstacle interference to avoid the intrusion.
Zenglin Zhang et al. (Zhang, Wu, Han, & Yu, 2017)	Remote monitoring system for agricultural information based on wireless sensor networks.	Proposed system has the sensor node. For the collection of data regarding the soil moisture. Fetched data is transmitted to the base station with the use of zigbee. Where user can analyse the data and this system work effectively in controlling the proper required irrigation.
Mohit Kumar Navinay et al. (kumar Navinay & Gedam, 2017)	A Review Paper on the Internet of Things based Application Smart Agricultural System.	Authors have used the Kalman filter to improve the accuracy of the sensed data. A protocol is used which works on the gathered data and the weather conditions to achieve the automation of the irrigation system and roofing system. System works according to the irrigation requirement of the crops while all the sensed data is stored to the cloud as the size of the data fetched by the sensors from its surroundings.
Dweepayan Mishra et al. (Mishra, Khan, Tiwari, & Upadhyay, 2018)	Automated Irrigation System-IoT Based Approach.	The proposed system checks the amount of water required by a plant, with predefined values in the program. A threshold value has been set according to which the smart irrigation will take place so that the crop gets the required amount of water needed by it. Automatic irrigation is achieved through water pumps according to the requirement of the crops.
Priyanka Padalalu et al. (Padalalu, Mahajan, Dabir, Mitkar, & Javale, 2017)	Smart Water Dripping System for Agriculture/ Farming.	On the bases of the sensed data by the consisting sensors in the system regarding the soil parameters or condition of the soil. Predefined value were given to the systems. These predefined values further instruct the system whether to turn the system on or off. If there is any fault in the system regarding the irrigation, an alert system is there to alert the user through an android application. If the conditions are rainy this system works perfectly and allow user to have knowledge regarding the weather condition as at this time, there is a lesser need of irrigation. To achieve these functions authors have used Arduino microcontroller.
Vaishali S et al. (Vaishali, Suraj, Vignesh, Dhivya, & Udhayakumar, 2018)	Mobile Integrated Smart Irrigation Management and Monitoring System Using IoT	In this paper, the authors successfully developed and implemented a system for automated irrigation by analysing the moisture content of the soil. With the use of raspberry pi, the system can control the water pump according to the requirement.
Manali Hate et al. (Hate, Jadhav, & Patil, 2018)	Vegetable Traceability with Smart Irrigation using IoT	The proposed system is based on Microcontroller, and the system could provide real-time feedback. The system can be used to monitor and control all the required processes effectively. The system can reduce water wastage.
Revanth Kondaveti et al. (Kondaveti, Reddy, & Palabtlu, 2019)	Smart Irrigation System Using Machine Learning and IoT	The proposed system in this paper has the capability of predicting rainfall with an effective irrigation system
Anushree Math et al. (Math, Ali, & Pruthviraj, 2019)	Development of Smart Drip Irrigation System Using IoT	In this paper, the authors presented that Deep learning and AI can be used to detect disease and pest in the crop with the help of image processing. They have developed an android based app to keep the records; the database will store all the information received from the sensors. As the backup, if there is no connectivity via the internet system will keep updated its user through SMS. A whole dedicated project is to create a smart, effective irrigation system using the Internet of Things.

continue on following page

Table 2. Continued

Author	Paper Title	Paper Description
Hamza Benyezza (Benyezza, Bouhedda, Djellout, & Saidi, 2019)	Smart Irrigation System based Thingspeak and Arduino	The smart Irrigation system is implemented with the help of Arduino and ESP8266 for the connectivity of the system. All data transmitted through DHT11 digital Temperature and Moisture Sensor and Soil moisture sensor can easily be transmitted to the cloud platform. So that data can easily be stored for future reference.
Rahat Hossain Faisal(Faisal, Saha, Hasan, & Kundu, 2019)	Power Efficient Distant Controlled Smart Irrigation System for AMAN and BORO Rice	An energy-efficient smart irrigation system is proposed in this paper. This system is best suited for only those crops which need to maintain a certain level of water for its growth. The system works on soil moisture; they have added weather prediction to get a more effective result.
Anubhav Gulati (Gulati & Thakur, 2018)	Smart Irrigation Using Internet of Things	The proposed system automates the irrigation process, which helps to save water, time, and money with the help of IoT. To achieve the goal, authors have used the Soil moisture sensor and Temperature Sensor LM35.
Yashaswini (Yashaswini, Vani, Sinchana, & Kumar, 2018)	Smart Automated Irrigation System with Disease Prediction	The system design includes soil moisture sensors, temperature sensors, leaf wetness sensors deployed in the agriculture field, the sensed data from sensors will be compared with predetermined threshold values of various soil and specific crops. The deployed sensors data are fed to the Arduino Uno processor which is linked to the data centre wirelessly via GSM module
(Ayaz, Ahammad-Uddin, Sharif, Mansour, & Aggoune, 2019)	Internet-of-Things (IoT)-Based Smart Agriculture: Toward Making the Fields Talk	Authors have discussed about the potential of WSN and Internet of things in agriculture, as they have claimed that the agricultural industry is data centric nowadays. Challenges in front of IoT and WSN have been discussed. Communication protocols and processes were discussed in detail. Different types of sensor details were provided covering almost all agricultural process like, Soil preparation, crop status, irrigation, insects, and pest detection. Role of UAV for the agricultural process have also been discussed.
(Elijah, Rahman, Orikumhi, Leow, & Hindia, 2018)	An Overview of Internet of Things (IoT) and Data Analytics in Agriculture: Benefits and Challenges	In this paper authors have discussed about the various advantages of the IoT, similarly various challenges faced by the IoT technology have also been discussed. They have shown the importance of the data analytics in the field of the smart agriculture combining it with IoT devices. Some trends and applications or the same have been given in this paper. Marketability for this technology is presented.
Raja, L., & Vyas, S. (2019).	The Study of Technological Development in the Field of Smart Farming.	Current technological parameters were discussed in this chapter. Role of agricultural automation, irrigation systems, IoT and wireless communications are main broad topics that were discussed in this chapter
Bhatnagar, V., & Poonia, R. C. (2019)	Sustainable Development in Agriculture: Past and Present Scenario of Indian Agriculture.	In this chapter authors have discussed about the importance of agriculture and also the various factors affecting the development of the agricultural business or agriculture, various scenarios have also been discussed in this chapter like the current status of Indian agriculture, international scenario of agriculture. Moreover, they typically have described about the status of the Rajasthan agriculture. All factors required for the agriculture like irrigation techniques, crops (types of crops), fertilization methods, consumption of fertilizers, production of crops also elaborated in this chapter.
Umamaheswari, S. (2019)	Internet of Things Practices for Smart Agriculture.	A Prototype for the smart irrigation system has been proposed by the authors in this chapter. They described that how IoT practises are important in smart agriculture, with the help of Internet of things farmers are able to analyse the data and implement it in a manner to improve the production from their respective farming fields.
Kumar, S., Yadav, A., & Sharma, D. K. (2020)	Deep Learning and Computer Vision in Smart Agriculture	Smart agriculture is an integration of many different technologies by which farmer can monitor, analyse and can operate various activities required at the different-different stages of the crop growth. In this book chapter authors have presented and discussed a detailed explanation over different kinds of deep learning methods

- If the value of the waterflow is under threshold value, the motor will be switched on. If the value exceeds threshold value, motor will be turned off automatically.
- To fulfil the requirement of power required by the system solar system is used which power ups the whole system.

Figure 4. Block Diagram of Intelligent Irrigation System

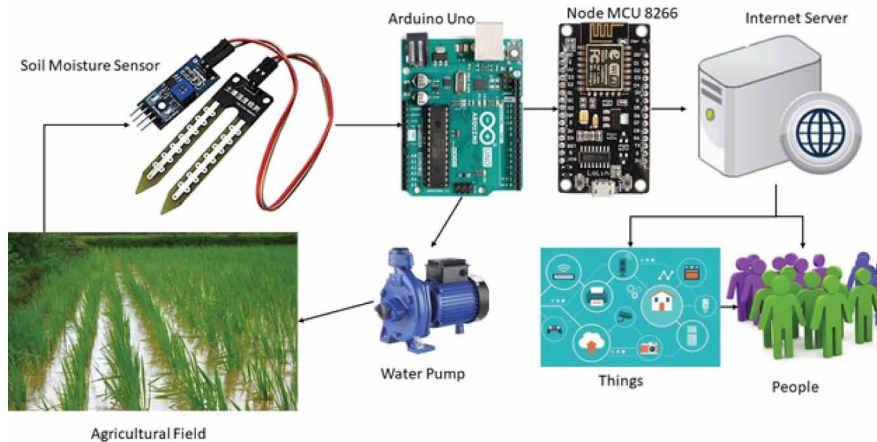

Proposed system is implemented using embedded electronics both software and hardware is implemented. Different working fields of the system can describe as following:

- **Data Collection Real-Time Monitoring:** We are using a water flow sensor to measure the amount of water and pH sensor to measure the pH value of soil. Due to the regular feature of the pH sensor, we used this sensor in the proposed model. pH sensor is tiny in size and the requirement of the power consumption is very less. It has very high sensing range. Moisture sensor is used to measure the content of the aqua inside the soil.
- **Node MCU:** ESP8266 module is used. It collects data from the connected sensors and Arduino. All collected data is sent to the server through WI-FI connectivity of internet connectivity.
- **Water Flow Sensor:** Water flow sensor comprises of a plastic valve body, a water rotor, and a corridor impact sensor. At the point when water moves through the rotor, rotor rolls. Its speed changes with the various rate of the stream. The lobby impact sensor yields the comparing

Figure 5. Circuit Diagram of Proposed Model

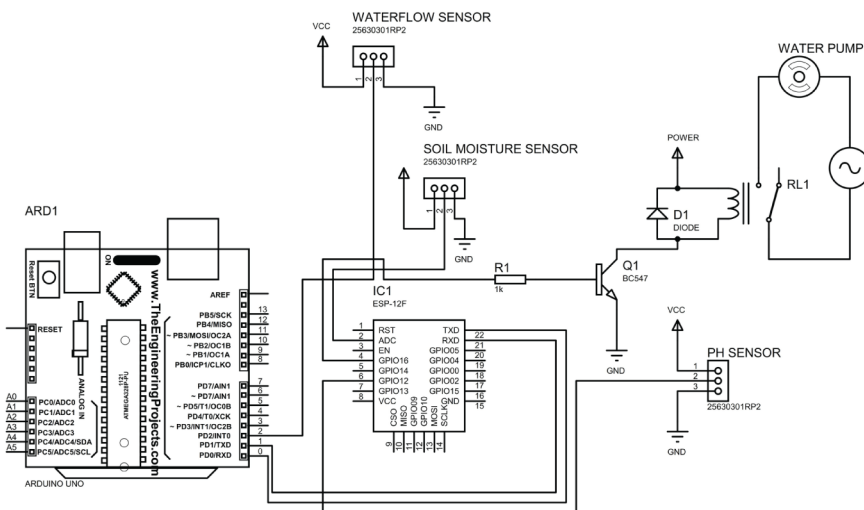

heartbeat signal. This one is appropriate to distinguish flow in a water container or espresso machine. The concept of dashboard is introduced it is very much like the website. Class. shoolinilabs.com server is used in this proposed system. It allows user to monitor parameters like flow of water, pH, moisture content etc. on the basis of data received by these parameters' user can keep an eye on the automation of the water pump. The flow chart of the proposed IIS is shown in Figure 6, which is specially designed for rice crops according to the soil moisture level and their pH value. The soil pH value is a measure of soil acidity or alkalinity.

The proposed model is work based on the pH value of rice crop and the range of soil pH value given in Figure 7.

Figure 6. Complete circuit running Model in real time environment



The pH estimation of soil is one of the various natural conditions that influence the nature of plant development (Figure 8). The dirt pH esteem straightforwardly influences supplement accessibility. Plants flourish best in various soil pH ranges. Azaleas, rhododendrons, blueberries, and conifers flourish best in corrosive soils (pH 5.0 to 5.5). Vegetables, grasses, and most ornamentals do best in somewhat acidic soils (pH 5.8 to 6.5). Soil pH esteems above or underneath these extents may bring about less incredible development and supplement insufficiencies (Rani, Kumar, & Bhushan, 2020).

Components Affecting Soil pH: There some point written which can affect the soil pH value:

- The pH estimation of dirt is affected by the sorts of parent materials from which the dirt was framed. Soils created from.
- First shakes, for the most part, have higher pH esteems than those shaped from corrosive rocks.
- Precipitation additionally influences soil pH value. Water going through the dirt drains essential supplements, for example, calcium and magnesium from the dirt. They are supplanted by acidic.
- Components, for example, aluminum and iron. Thus, soils shaped under high precipitation conditions are more acidic than those framed under (dry) conditions.

Figure 7. Flow Chart of the proposed IIS methodology

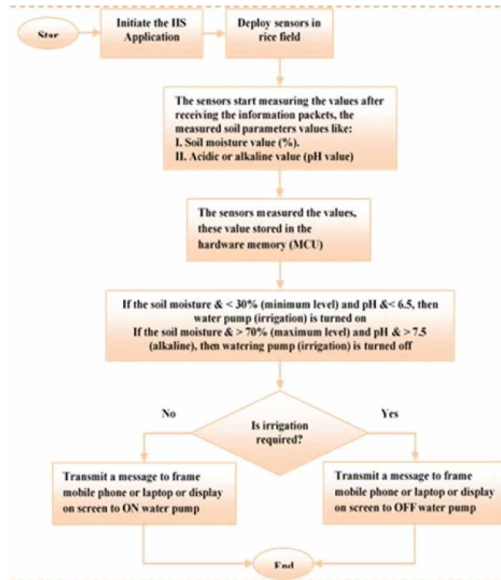
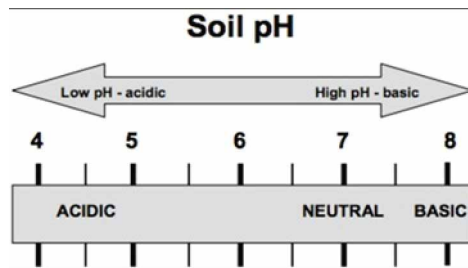

Figure 8. Soil pH value with nature



- The utilization of composts containing ammonium or urea accelerates the rate at which corrosiveness creates. The decay of natural issues additionally adds to soil sharpness.
- Proposed system is designed and implemented for the water management in paddy crops. Water is essential for the growth and development of rice plants. However, continuous flooding results in many unproductive water outflows through evaporation, seepage, and percolation. Growing evidence indicates that continuous flooding is unnecessary for the rice to achieve high yields, which, however, is based on short-term trials. Long-term field water conditions would produce profound changes in soil properties, which may further affect soil water conservation and crop yield. However, few studies have been conducted on the long-term field trial. So, there is little information on water consumption, crop yield, and water productivity after the long-term adoption of water-saving irrigation.

4. RESULTS AND DISCUSSION

In this section, the experimental results of proposed IIS for rice crop monitoring using IoT communication are discussed, and the efficiency of the proposed work is compared with existing work (Rani et al., 2020). The experimental results of the proposed IIS are shown in Table 3.

Table 3. Results based on performance

Net Water Flow	Soil Moisture	pH Value	Water Pump Status
518 ml	45%	7.1	On
489ml	30%	6.5	On
241ml	32%	7.8	On
1000ml	43%	7.0	On
1589ml	32%	7.3	Off
1581ml	45%	6.9	Off
2000ml	55%	7.2	Off

To make soils less acidic, the essential practice is to apply a material that contains some type of lime. Ground horticultural limestone is most now and again utilized. The better the limestone particles, the more quickly it winds up successful. Various soils will require an alternate measure of lime to modify the dirt pH esteem. The surface of the dirt, original issue content, and the plants to be developed are on the whole factors to consider in modifying the pH esteem. For instance, soils low in dirt require less lime than soils. High in mud to make a similar pH change. Numerous fancy plants and some natural product plants, for example, rice, require somewhat to unequivocally corrosive soil. These species create iron chlorosis when developed in soils in the antacid range. Iron chlorosis is regularly mistaken for nitrogen inadequacy because the indications (a clear yellowing of the leaves) are comparable. Iron chlorosis can be revised by lessening the dirt pH value. The most significant impact that extremes in pH value have on rice plant growth is related to the availability of plant nutrients or the soil concentration of toxic minerals.

Table 3 and Figure 9 represent the effect of pH value on the rice crop irrigation system, and the performance of the proposed ISS is better because of the use of the IoT network for fast response to farmers.

Figure 9. Effect of pH Value

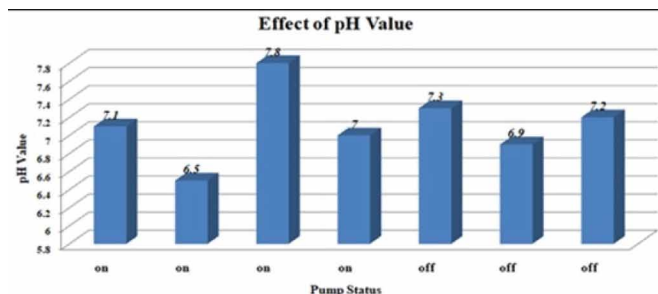

4.1. Real-Time Output on Server

See Figures 10-11.

Figure 10. Web server-based dashboard for turning ON and OFF water pump



Figure 11. Data stored on web server for Net Water Flow and the pH level

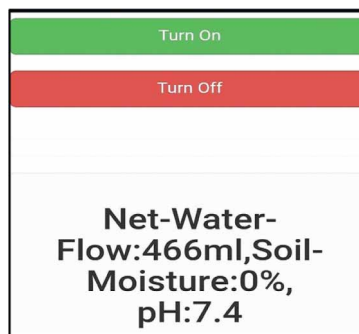

5. CONCLUSION AND FUTURE WORK

For the effective utilization of the water in agriculture, it is mandatory to have a system that can support the farmer and act as a guide to irrigate their fields. It is evident that rainwater and the groundwater levels are decreasing day-by-day, thereby increasing the requirement of new systems to utilize the water resources effectively for agriculture. Moreover, it is a known fact that the economy and growth of a country purely depends on the agricultural income. In this paper, ISS for rice crop monitoring using IoT based communication system is proposed. We have analyzed our implemented model is adequate and accurate and having a speedy response time due to the use of IoT based network. The experimental results of ISS are more proficient than the existing conventional and unadventurous irrigation approach for rice crops. From the analysis, we concluded that the installation of IIS saves time and ensures practical usage of water in a rice crop field. In the future of irrigation systems, the work can be extended to a large scale by incorporating the WSN in the agricultural fields with the concept of artificial intelligence mechanism, which can provide accurate and useful results for different types of crops.

ACKNOWLEDGMENT

We would like to acknowledge Mr. Neeraj Pizar, Assistant Professor (English), member scientific writing cell, Shoolini University of Biotechnology & Management Science, Solan, Himachal Pradesh, for thorough language and grammar editing.

REFERENCES

- Ayaz, M., Ammad-Uddin, M., Sharif, Z., Mansour, A., & Aggoune, E. H. M. (2019). Internet-of-Things (IoT)-based smart agriculture: Toward making the fields talk. *IEEE Access: Practical Innovations, Open Solutions*, 7, 129551–129583. doi:10.1109/ACCESS.2019.2932609
- Barkunan, S. R., Bhanumathi, V., & Sethuram, J. (2019). Smart sensor for automatic drip irrigation system for paddy cultivation. *Computers & Electrical Engineering*, 73, 180–193. doi:10.1016/j.compeleceng.2018.11.013
- Basu, D., & Ghosh, S. (2016). Smart Farming using IoT using solar panel. *Alliedelec*, 278–280.
- Benyezza, H., Bouhedda, M., Djellout, K., & Saidi, A. (2019). Smart Irrigation System Based Thingspeak and Arduino. *Proceedings of the 2018 International Conference on Applied Smart Systems, ICASS 2018*. doi:10.1109/ICASS.2018.8651993
- Bhatt, H., Bhushan, B., & Kumar, N. (2019). IOT: The Current Scenario and Role of Sensors Involved in Smart Agriculture. *International Journal of Recent Technology and Engineering*, 8(4), 12011–12023. doi:10.35940/ijrte.D9285.118419
- Deshpande, V., & Prasad, J. P. (2015). *Automated Irrigation System Using a Wireless Sensor Network and GPRS Module*. 10.3850/978-981-09-6200-5_d-51
- Elijah, O., Rahman, T. A., Orikumhi, I., Leow, C. Y., & Hindia, M. N. (2018). An Overview of Internet of Things (IoT) and Data Analytics in Agriculture: Benefits and Challenges. *IEEE Internet of Things Journal*, 5(5), 3758–3773. doi:10.1109/JIOT.2018.2844296
- Faisal, R. H., Saha, C., Hasan, M. H., & Kundu, P. K. (2019). Power Efficient Distant Controlled Smart Irrigation System for AMAN and BORO Rice. *2018 21st International Conference of Computer and Information Technology, ICCIT 2018*, 1–5. doi:10.1109/ICCITECHN.2018.8631927
- Gondchawar, N., & Kawitkar, R. S. (2016). IoT based smart agriculture. *International Journal of Advanced Research in Computer and Communication Engineering*, 5(6), 838–842. doi:10.17148/IJARCC.2016.56188
- Gulati, A., & Thakur, S. (2018). Smart Irrigation Using Internet of Things. *Proceedings of the 8th International Conference Confluence 2018 on Cloud Computing, Data Science and Engineering, Confluence 2018*, 819–823. doi:10.1109/CONFLUENCE.2018.8442928
- Hate, M., Jadhav, S., & Patil, H. (2018). Vegetable Traceability with Smart Irrigation. *2018 International Conference on Smart City and Emerging Technology, ICSCET 2018*, 1–4. doi:10.1109/ICSCET.2018.8537253
- Kamelia, Ramdhani, Feroqi, & Rifadiapriyana. (2018). *Implementation of Automation System for Humidity Monitoring and Irrigation System*. 10.1088/1757-899X/288/1/012092
- Kondaveti, R., Reddy, A., & Palabtl, S. (2019). Smart Irrigation System Using Machine Learning and IOT. *Proceedings - International Conference on Vision Towards Emerging Trends in Communication and Networking, ViTECoN 2019*, 1–11. doi:10.1109/ViTECoN.2019.8899433
- Kumar, N., & Sharma, B. (2020). Opportunities and Challenges with WSN's in Smart Technologies: A Smart Agriculture Perspective. *Advances in Intelligent Systems and Computing*, 1132, 441–463. doi:10.1007/978-3-030-40305-8_22
- Kumar Navinay, M., & Gedam, R. (2017). A Review Paper on Internet of things based Application Smart Agricultural System. *International Journal of Latest Engineering and Management Research*, 2(4), 69–71.
- Li & He. (2019). *Design of rice intelligent water-saving irrigation system based on agricultural internet of things*. 10.1088/1742-6596/1176/5/052068
- Math, A., Ali, L., & Pruthviraj, U. (2019). Development of Smart Drip Irrigation System Using IoT. *2018 IEEE Distributed Computing, VLSI, Electrical Circuits and Robotics, DISCOVER 2018 - Proceedings*, 126–130. 10.1109/DISCOVER.2018.8674080
- Mishra, D., Khan, A., Tiwari, R., & Upadhyay, S. (2018). Automated Irrigation System-IoT Based Approach. *Proceedings - 2018 3rd International Conference On Internet of Things: Smart Innovation and Usages, IoT-SIU 2018*, 1–4. doi:10.1109/IoT-SIU.2018.8519886

- Muangprathub, J., Boonnam, N., Kajornkasirat, S., Lekbangpong, N., Wanichsombat, A., & Nillaor, P. (2019). IoT and agriculture data analysis for smart farm. *Computers and Electronics in Agriculture*, 156(December), 467–474. 10.1016/j.compag.2018.12.011
- Nageswara Rao, R., & Sridhar, B. (2018). IoT based smart crop-field monitoring and automation irrigation system. *2018 2nd International Conference on Inventive Systems and Control (ICISC)*, 478–483.
- Padalalu, P., Mahajan, S., Dabir, K., Mitkar, S., & Javale, D. (2017). Smart water dripping system for agriculture/farming. *2017 2nd International Conference for Convergence in Technology, I2CT 2017*, 659–662. doi:10.1109/I2CT.2017.8226212
- Rani, D., Kumar, N., & Bhushan, B. (2020). *Implementation of an Automated Irrigation System for Agriculture Monitoring using IoT Communication*. 10.1109/ispsc48220.2019.8988390
- Rasooli, M. W., Bhushan, B., & Kumar, N. (2020). Applicability of WSN& IoT in saffron & wheat crops: A smart agriculture perspective. *International Journal of Scientific and Technology Research*, 9(2), 2456–2461.
- Saraf, S. B., & Gawali, D. H. (2017). IoT based smart irrigation monitoring and controlling system. *RTEICT 2017 - 2nd IEEE International Conference on Recent Trends in Electronics, Information and Communication Technology, Proceedings*, 815–819. doi:10.1109/RTEICT.2017.8256711
- Sharma, B. B., & Kumar, N. (2020). Internet of things-based hardware and software for smart agriculture: A review. *Lecture Notes in Electrical Engineering*, 597, 151–157. doi:10.1007/978-3-030-29407-6_13
- Vaishali, S., Suraj, S., Vignesh, G., Dhivya, S., & Udhayakumar, S. (2018). Mobile integrated smart irrigation management and monitoring system using IOT. *Proceedings of the 2017 IEEE International Conference on Communication and Signal Processing, ICCSP 2017*, 2164–2167. doi:10.1109/ICCSP.2017.8286792
- Yashaswini, L. S., Vani, H. U., Sinchana, H. N., & Kumar, N. (2018). Smart automated irrigation system with disease prediction. *IEEE International Conference on Power, Control, Signals and Instrumentation Engineering, ICPCSI 2017*, 422–427. doi:10.1109/ICPCSI.2017.8392329
- Zhang, Z., Wu, P., Han, W., & Yu, X. (2017). Remote monitoring system for agricultural information based on wireless sensor network. *Journal of the Chinese Institute of Engineers, Transactions of the Chinese Institute of Engineers, Series A/Chung-Kuo Kung Ch'eng Hsuch K'an*, 40(1), 75–81. 10.1080/02533839.2016.1273140

Brij Bhushan Sharma is an assistant professor. They have their M. Tech (ECE) and are pursuing their PhD in the Yogananda School of AI, Computer and Data Sciences at Shoolini University. Their research Areas are: Wireless Sensor Networks, Internet of Things and Embedded Electronics.

Nagesh Kumar is an assistant professor in the Yogananda School of AI, Computer and Data Sciences at Shoolini University. Their research Areas are: Sensor Networks, Internet of Things, Computer Network and Security.